

NATUCER  
*cerámica natural*



NATUCER

NATUCER CUORE, S.L.U C/ Les Forques, 2  
12200 Onda [Castellón] Spain · Apdo. nº 6  
Tel.: + [34] 964 60 40 66 [8 líneas]  
info@natucer.es · www.natucer.es

NATUCER  
*cerámica natural*

# ¿QUIENES SOMOS?

WHO WE ARE?

QUI SOMMES-NOUS?

Natucer inicia su andadura en la década de los 90, coincidiendo con el asentamiento de la revolución tecnológica española, ocurrida con la obtención de los revestimientos prensados con cocciones rápidas. Ofrece soluciones en gres porcelánico extrusionado para interiores y exteriores.

Pavimentos que integran funcionalidad, máxima calidad y un diseño con esencia artesanal.

Especialistas en todo tipo de piezas especiales que garantizan un acabado perfecto, como peldaños de gran formato o piezas específicas y técnicas para piscina.

Y revestimientos exclusivos al servicio de arquitectos, interioristas y decoradores sin limitaciones en cuanto a colores, formas, texturas, geometrías y volúmenes, para proyectos tanto residenciales como públicos o comerciales.

Natucer started by the end of the 90's, matching up with the Spanish technological revolution and the production of pressed wall tiles through quick fire. Natucer offers lots of possibilities inside and outside using our klinker extruded porcelain tile.

Floor tiles that join the functionality with the maximum quality and a design with artisanal essence. Natucer is specialized in all type of special pieces to make a perfect finish, such as large steps 120 cm long, or special technic pieces for pools.

Wall tiles that have been created for architects and interior designers that look unique and exclusive finishes, without limitation in colors, sizes, textures, 3Ds for all projects: residential, public and commercial.

Natucer a débuté son activité dans les années 90, coïncidant avec l'essor de la révolution technologique espagnole, marquée par l'apparition des revêtements pressés à cuisson rapide. Elle propose des solutions en grès cérame extrudé pour l'intérieur comme pour l'extérieur : des pavements qui allient fonctionnalité, qualité maximale et design à l'essence artisanale.

Spécialistes de tous types de pièces spéciales garantissant une finition parfaite, telles que des marches de grand format ou des éléments techniques spécifiques pour piscines.

Des revêtements exclusifs au service des architectes, designers d'intérieur et décorateurs, sans limitation de couleurs, formes, textures, géométries ou volumes, pour des projets résidentiels, publics ou commerciaux.

*cerámica natural*

**NATUCER**  
*cerámica natural*

Since 1988

# ¿QUÉ HACEMOS?

WHAT WE DO?  
QUE FAISONS-NOUS?

Utilizamos únicamente las mejores materias primas: arcillas naturales y agua, sometidas a un proceso de molido especial que aumenta la densidad y minimiza la porosidad.

Esta mezcla pasa posteriormente por la extrusora, una boquilla que forma el volumen de las piezas. De esta manera se obtiene una pasta densa y homogénea que se corta en piezas de cualquier tamaño y forma deseada, logrando un producto único donde ninguna pieza es igual a otra.

Cocido a 1300 grados, lo que otorga al gres extrusionado su excepcional dureza y resistencia. Durante este proceso, las partículas de arcilla se fusionan, formando una estructura increíblemente compacta y sólida.

El resultado es un producto inalterable al paso del tiempo, resistente al hielo, antideslizante, ignífugo, higiénico, de fácil limpieza y con mantenimiento prácticamente inexistente. Además, el sistema de producción por extrusión permite una infinita variedad de formas, volúmenes y texturas, lo que hace de cada pieza una creación singular e irreplicable.

We use only the finest raw materials: natural clays and water, subjected to a special grinding process that increases density and minimizes porosity.

This mixture then passes through the extrusion machine, a nozzle that shapes the volume of the pieces. In this way, a dense and homogeneous paste is obtained, which is cut into pieces of any desired size and shape, resulting in a unique product where no two pieces are alike.

Fired at 1300 degrees, this process gives extruded stoneware its exceptional hardness and strength. During firing, the clay particles fuse together, forming an incredibly compact and solid structure.

The result is a product that remains unchanged over time, resistant to frost, non-slip, fireproof, hygienic, easy to clean, and virtually maintenance-free. Moreover, the extrusion production system allows us to create infinite variety of shapes, volumes, and textures, making each piece a unique and unrepeatable creation.

Nous utilisons exclusivement les meilleures matières premières : des argiles naturelles et de l'eau, soumises à un procédé de broyage spécifique qui augmente la densité et minimise la porosité.

Ce mélange passe ensuite par une extrudeuse, une filière qui donne le volume aux pièces. On obtient ainsi une pâte dense et homogène, découpée en éléments de toutes tailles et formes souhaitées, donnant naissance à un produit unique où aucune pièce n'est identique à une autre.

Cuite à 1300°C, cette matière confère au grès extrudé une dureté et une résistance exceptionnelles. Durant ce processus, les particules d'argile fusionnent pour former une structure extrêmement compacte et solide.

Le résultat est un produit : Inaltérable dans le temps résistant au gel, antidérapant, ignifuge, hygiénique, facile à nettoyer, nécessitant un entretien quasi inexistant. Le système de production par extrusion permet également une variété infinie de formes, volumes et textures, faisant de chaque pièce une création singulière et irréplicable.



## ESPECIALIZADOS EN GRES PORCELÁNICO EXTRUSIONADO

SPECIALIZED IN EXTRUDED PORCELAIN STONEWARE  
SPÉCIALISTES EN GRÈS CÉRAME EXTRUDÉ



TRADICIÓN Y NATURAL  
TRADITION AND NATURE  
TRADITIONNEL ET NATUREL



EFICIENCIA ENERGÉTICA  
ENERGY EFFICIENCY  
EFFICACITÉ ÉNERGÉTIQUE



SEGURA  
SAFE  
SÛR



IGNÍFUGA  
FIREPROOF  
IGNIFUGE



HIGIÉNICA Y ANTIALERGÉNICA  
HYGIENIC AND ANTI-ALLERGENIC  
HYGIÉNIQUE ET ANTIALLERGÉNIQUE



DURADERA Y RESISTENTE  
DURABLE AND RESISTANT  
DURABLE ET RÉSISTANT



LIMPIEZA Y MANTENIMIENTO  
CLEANING AND MAINTENANCE  
FACILE À NETTOYER ET À ENTREtenir



ESTÉTICA Y VERSÁTIL  
ESTHETIC AND VERSATILE  
ESTHÉTIQUE ET POLYVALENT



RESPONSABLE Y SOSTENIBLE  
RESPONSIBLE AND SUSTAINABLE  
RESPONSABLE ET DURABLE

# ¿CÓMO LO HACEMOS?

HOW WE DO IT?  
COMMENT LE FAISONS-NOUS?

## PREOCUPADOS.

La preocupación por el cuidado del entorno y la preservación del medioambiente han sido prioridad para la creación de esta nueva marca de la empresa Natucer. La sostenibilidad de nuestro estilo de vida y su necesario equilibrio con el medioambiente necesita de hechos concretos y acciones tangibles. Natucer es responsable en el proceso de fabricación para minimizar su impacto en el medioambiente.

## COMPROMETIDOS.

Natucer se compromete con el cuidado del medioambiente y con los efectos que repercuten en el entorno debido a su actividad. Ha realizado importantes inversiones en infraestructura para adaptar y aplicar las mejoras técnicas y menos contaminantes en los procesos productivos. Algunos de los requisitos que se deben cumplir, entre otros, son: Vertidos, Emisiones atmosféricas y Gestión y procedimientos de residuos.

## CONCERNED.

Concern for environmental care and preservation has been a priority in the creation of this new brand by Natucer. The sustainability of our lifestyle and its necessary balance with the environment requires concrete actions and tangible actions. Natucer is responsible in the manufacturing process to minimize its impact on the environment.

## COMMITTED.

Natucer is committed to caring for the environment and addressing the effects its activities have on the environment. It has made significant investments in infrastructure to adapt and implement technical improvements and reduce pollution in its production processes. Some of the requirements that must be met, among others, are: Discharges, Air Emissions, and Waste Management and Procedures.

## ENGAGÉS POUR L'ENVIRONNEMENT.

La préservation de l'environnement est une priorité dans la création de cette nouvelle marque. La durabilité de notre mode de vie et son nécessaire équilibre avec l'environnement exigent des actions concrètes et mesurables. Natucer agit de manière responsable dans ses processus de fabrication afin de minimiser son impact environnemental.

## COMPROMIS.

Des investissements significatifs ont été réalisés pour adapter les infrastructures et intégrer les meilleures technologies disponibles dans les processus productifs, notamment en matière de: rejets, émissions atmosphériques, gestion des déchets.

# PREOCUPADOS Y COMPROMETIDOS CON EL MEDIOAMBIENTE

CONCERNED AND COMMITTED TO THE ENVIRONMENT  
SOUCIEUX ET ENGAGÉS POUR L'ENVIRONNEMENT



**Contaminación acústica regulada**  
Regulated noise contamination  
Pollution acoustique contrôlée

**Continuo reciclaje**  
Continuous recycling  
Recyclage continu



**Ahorro energético fundamental**  
Fundamental energy savings  
Économie d'énergie

**Emisiones atmosféricas controladas**  
Controlled atmospheric emissions  
Émissions atmosphériques maîtrisées



**Gestión adecuada de los residuos**  
Correct waste management  
Gestion responsable des déchets

**Vertido cero**  
Zero waste  
Zéro rejet

# - PROBLEMAS + SOLUCIONES

- PROBLEMS + SOLUTIONS  
- PROBLÈMES + SOLUTIONS

Natucer cuenta con una gran variedad de piezas especiales que no sólo garantizan un acabado perfecto, sino que también permiten resolver estéticamente aspectos arquitectónicos como bordes de piscina o escaleras. Piezas diseñadas para lograr soluciones específicas para pavimentos exigentes.

Natucer ofrece un pavimento ideal para emplazamientos arquitectónicos exteriores y zonas húmedas que precisen de exigentes prestaciones frente al deslizamiento. Pensado y fabricado para garantizar la máxima seguridad.

Natucer has a great variety of special pieces that not only guarantee a perfect finish, but also enables giving aesthetically ideas to architectural aspects such as edges of pool or stairs. Pieces designed to achieve specific solutions for specific floors.

Natucer offers an ideal floor for humid areas and exterior architectural sites that require special conditions in order to be antislip and avoid sliding. Designed and manufactured to guarantee maximum safety.

Natucer propose une large gamme de pièces spéciales garantissant non seulement une finition parfaite, mais permettant également de résoudre esthétiquement des éléments architecturaux tels que les bords de piscine ou les escaliers.

Des pièces conçues pour répondre aux exigences des pavements techniques, notamment en extérieur ou dans les zones humides nécessitant des performances élevées en matière d'antidérapance. Pensées et fabriquées pour garantir une sécurité maximale.

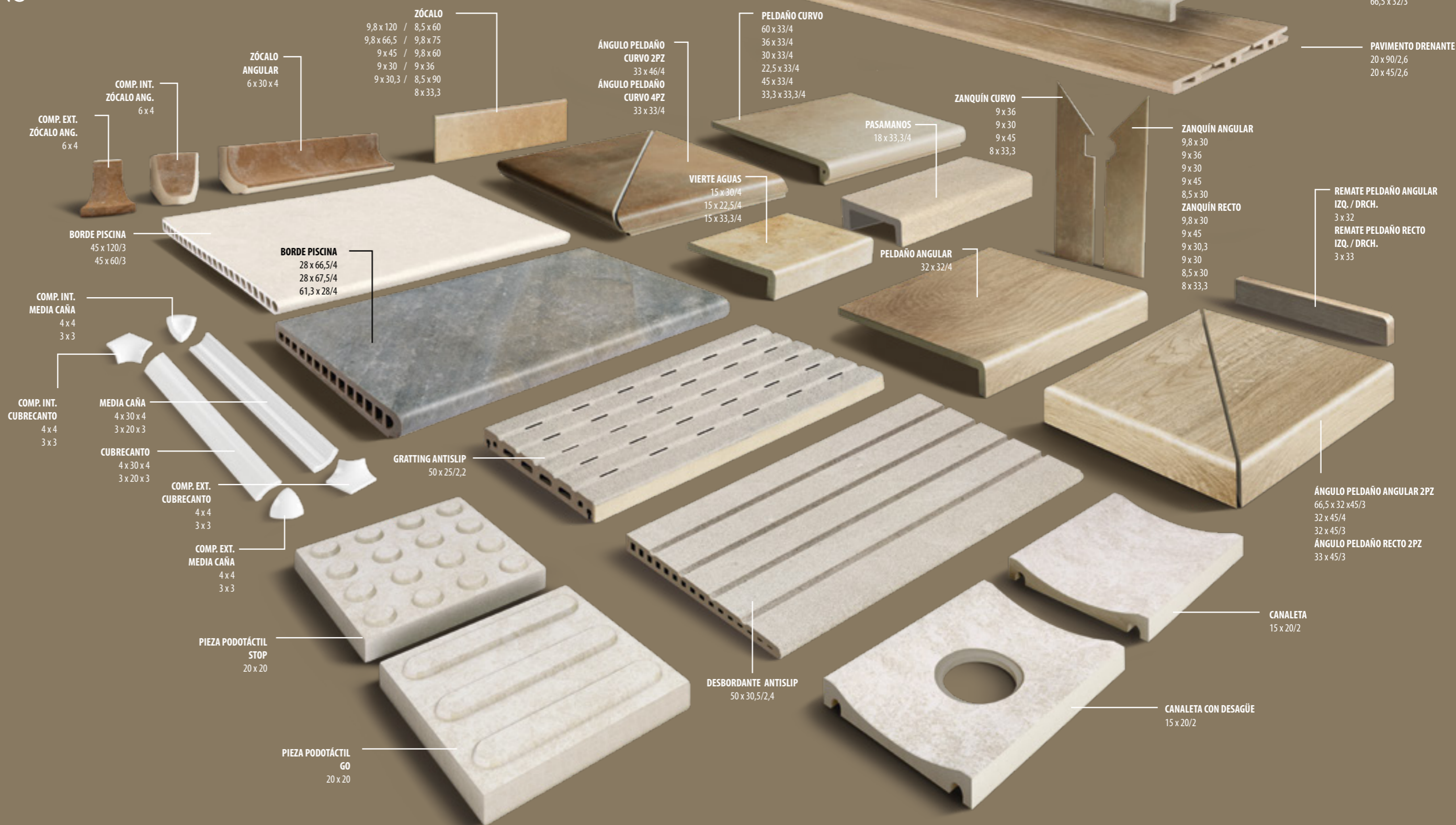

STEP 150  
STEP 120

PELDAÑO BLOCK  
120 x 33/1,4

PELDAÑO RECTO  
150 x 33/3  
120 x 33/3  
120 x 32/3  
60 x 33/3  
60 x 32/3  
45 x 32/3

PELDAÑO RECTO  
CON GOTERÓN  
61,3 x 32/3  
33,3 x 33,3/3

PELDAÑO ANGULAR  
120 x 32/3  
60 x 32/3  
67,5 x 32/3  
66,5 x 32/3

PAVIMENTO DRENANTE  
20 x 90/2,6  
20 x 45/2,6

ZÓCALO  
9,8 x 120 / 8,5 x 60  
9,8 x 66,5 / 9,8 x 75  
9 x 45 / 9,8 x 60  
9 x 30 / 9 x 36  
9 x 30,3 / 8,5 x 90  
8 x 33,3

ZÓCALO  
ANGULAR  
6 x 30 x 4

COMP. INT.  
ZÓCALO ANG.  
6 x 4

COMP. EXT.  
ZÓCALO ANG.  
6 x 4

ÁNGULO PELDAÑO  
CURVO 2PZ  
33 x 46/4  
ÁNGULO PELDAÑO  
CURVO 4PZ  
33 x 33/4

PELDAÑO CURVO  
60 x 33/4  
36 x 33/4  
30 x 33/4  
22,5 x 33/4  
45 x 33/4  
33,3 x 33,3/4

ZANQUÍN CURVO  
9 x 36  
9 x 30  
9 x 45  
8 x 33,3

PASAMANOS  
18 x 33,3/4

ZANQUÍN ANGULAR  
9,8 x 30  
9 x 36  
9 x 30  
9 x 45  
8,5 x 30

VIERTE AGUAS  
15 x 30/4  
15 x 22,5/4  
15 x 33,3/4

ZANQUÍN RECTO  
9,8 x 30  
9 x 45  
9 x 30,3  
9 x 30  
8,5 x 30  
8 x 33,3

REMATE PELDAÑO ANGULAR  
IZQ. / DRCH.  
3 x 32  
REMATE PELDAÑO RECTO  
IZQ. / DRCH.  
3 x 33

BORDE PISCINA  
45 x 120/3  
45 x 60/3

BORDE PISCINA  
28 x 66,5/4  
28 x 67,5/4  
61,3 x 28/4

COMP. INT.  
MEDIA CAÑA  
4 x 4  
3 x 3

COMP. INT.  
CUBRECANTO  
4 x 4  
3 x 3

MEDIA CAÑA  
4 x 30 x 4  
3 x 20 x 3

CUBRECANTO  
4 x 30 x 4  
3 x 20 x 3

COMP. EXT.  
CUBRECANTO  
4 x 4  
3 x 3

COMP. EXT.  
MEDIA CAÑA  
4 x 4  
3 x 3

GRATING ANTISLIP  
50 x 25/2,2

ÁNGULO PELDAÑO ANGULAR 2PZ  
66,5 x 32 x 45/3  
32 x 45/4  
32 x 45/3  
ÁNGULO PELDAÑO RECTO 2PZ  
33 x 45/3

PIEZA PODOTÁCTIL  
STOP  
20 x 20

DESBORDANTE ANTISLIP  
50 x 30,5/2,4

CANALETA  
15 x 20/2

PIEZA PODOTÁCTIL  
GO  
20 x 20

CANALETA CON DESAGÜE  
15 x 20/2

# SIÉNTETE AUTOR DE TUS PROYECTOS CON NATUCER

WITH NATUCER, FEEL YOURSELF  
AS THE ARTIST OF YOUR PROYECTS  
SENTEZ-VOUS AUTEUR DE VOS PROJETS AVEC NATUCER

La cerámica se ha extendido por todo nuestro espacio. Sus propiedades de resistencia, versatilidad, seguridad y fácil mantenimiento además de ser antibacteriana e ignífuga han hecho que su zona de aplicación deje de limitarse a baños y cocinas.

Otra de sus ventajas es su capacidad de imitar otros materiales, que ni alcanzan las prestaciones que la cerámica ofrece ni son tan fáciles de mantener. Pudiendo así adaptarse a cualquier rincón del hogar, sea cual sea su estilo y con posibilidad de conseguir un interior coordinado con el exterior.

Tiles are all over our home. Its properties of resistance, versatility, safety and easy maintenance have made its application area no longer limited to bathrooms and kitchens.

The advantages of tiles are the ability to imitate other materials, which neither achieve the performance that ceramics offer but offer the easy maintainance of the tiles. Thus being able to adapt to any corner of the home, whatever its style is, and with the possibility of achieving an interior look of the house coordinated with the outside areas.

La cerámica s'est étendue à l'ensemble de nos espaces. Grâce à ses propriétés de résistance, de polyvalence, de sécurité et de facilité d'entretien, ainsi qu'à ses caractéristiques antibactériennes et ignifuges, son usage ne se limite plus aux salles de bains et aux cuisines.

Elle offre également la capacité d'imiter d'autres matériaux qui n'atteignent pas les performances techniques de la céramique et sont plus difficiles à entretenir.

Elle s'adapte ainsi à tous les espaces de vie, quel que soit le style, tout en permettant une parfaite continuité entre intérieur et extérieur.



Matera es la nueva tecnología de Natucer que impulsa el porcelánico a un nivel superior. Combina diseño y precisión tecnológica para crear superficies con carácter propio y excepcional. Cada pieza se convierte en una superficie única, donde relieves, texturas y acabados se integran con precisión para ofrecer una experiencia visual y táctil inigualable. Con Matora, el material trasciende su función tradicional, convirtiéndose en un elemento creativo y expresivo que aporta personalidad, elegancia y coherencia a proyectos arquitectónicos e interiores.

Su propuesta multiformato y acabados premium permiten a diseñadores y arquitectos explorar nuevas posibilidades, creando espacios con identidad y sofisticación. Matora garantiza calidad y durabilidad, consolidándose como referencia de innovación y diseño en el porcelánico, con soluciones que combinan estética, funcionalidad y alto valor, y una gran variedad de piezas especiales que aseguran acabado envolvente y continuidad visual en suelos, revestimientos y coronaciones, incluso para piscinas.

Matera is Natucer's new technology that takes porcelain to a higher level. It combines design and technological precision to create surfaces with exceptional character. Each piece becomes a unique surface, where reliefs, textures, and finishes integrate precisely to offer an unparalleled visual and tactile experience. With Matora, the material transcends its traditional function, becoming a creative and expressive element that adds personality, elegance, and coherence to architectural and interior projects.

Its multiformat range and premium finishes allow designers and architects to explore new possibilities, creating spaces with identity and sophistication. Matora guarantees quality and durability, establishing itself as a reference in porcelain innovation and design, with solutions that combine aesthetics, functionality, and high value, and a wide variety of special pieces that ensure seamless finishes and visual continuity in floors, coverings, and trims, even for pools.

Matera est la nouvelle technologie de Natucer qui élève le grès cérame à un niveau supérieur. Elle allie design et précision technologique pour créer des surfaces au caractère exceptionnel. Chaque pièce devient une surface unique, où reliefs, textures et finitions s'intègrent avec précision pour offrir une expérience visuelle et tactile incomparable. Avec Matora, le matériau dépasse sa fonction traditionnelle, devenant un élément créatif et expressif qui apporte personnalité, élégance et cohérence aux projets architecturaux et d'intérieur.

Sa gamme multiformat et ses finitions premium permettent aux designers et architectes d'explorer de nouvelles possibilités, créant des espaces avec identité et sophistication. Matora garantit qualité et durabilité, s'imposant comme une référence en innovation et design du grès cérame, avec des solutions alliant esthétique, fonctionnalité et grande valeur, et une grande variété de pièces spéciales assurant une finition harmonieuse et une continuité visuelle sur sols, revêtements et corniches, même pour les piscines.

# Índice General

GENERAL INDEX

## SERIES

ALMA	110 - 111	MARE NOSTRUM	238 - 239
ALPES	118 - 119	NATURA	150 - 153
ALQUÉZAR	154 - 155	NATUR-TECH	136 - 137
AMERICAN DECOR	66 - 67	NATUR TRANSIT 2.0	132 - 135
ANIMA	112 - 115	OLIMPO	120 - 121
ARGILE	44 - 47	ORION	108 - 109
ARGILE DECOR	48 - 49	PARK	156 - 157
ARTIES	162 - 169	PIASTRELLA MIX	222 - 223
AUSTRAL	218	PIEDRAS DEL BRUC	126 - 127
BOSTON	64 - 65	PIEMONTE	74 - 77
BOSTON BRICK	68 - 69	PIRINEOS	128 - 129
BOTANICA	148 - 149	POOL	224 - 225
CAPRI	207	POSETS	122 - 125
CERLER	176 - 181	RETRO	158 - 159
COOL	204 - 205	SAONA	170 - 175
COTTO BRICK	50 - 51	SARSEN STONE	96 - 107
COTTO NATURE	70 - 73	SARSEN STONE REV.	196 - 201
COTTAGE	30 - 33	SHERWOOD	142 - 145
COTTAGE DECOR	32 - 33	STOW / STOW MIX	226 - 227
D'ANTICATTO	58 - 59	TABARCA	228 - 231
D'ANTICATTO DECOR	60 - 63	TECH-GEO	130 - 131
EVOKE	216 - 217	TECH-LAND	78 - 79
FIKA	214 - 215	TECH-LAND DECOR	80 - 83
FRAME	232 - 233	TEMPO	234 - 237
FUEGO	34 - 43	TOSCANA	182 - 187
FUEGO DECOR	38 - 43	UNIKA	52 - 55
HERITAGE CLAY	84 - 95	UNIKA DECOR	56 - 57
HERITAGE CLAY REV.	190 - 195	VEGA	219
LANDS	22 - 29	WABI SABI	202 - 203
LIMESTONE	116 - 117	ZELLIGE	220 - 221
LINEAGE	208 - 213	ZERMATT	146 - 147
LIVERPOOL	206		

## NOVEDADES

ARTIES	162 - 169	SARSEN STONE	96 - 107
CERLER	176 - 181	SARSEN STONE REV.	196 - 201
HERITAGE CLAY	84 - 95	SAONA	170 - 175
HERITAGE CLAY REV.	190 - 195	SHERWOOD	138 - 145
LANDS	22 - 29	TOSCANA	182 - 187

## PAVIMENTO

FLOOR TILE	
ALMA	110 - 111
ALPES	118 - 119
ALQUÉZAR	154 - 155
AMERICAN DECOR	66 - 67
ANIMA	112 - 115
ARGILE	44 - 47
ARGILE DECOR	48 - 49
ARTIES	162 - 169
BOSTON	64 - 65
BOSTON BRICK	68 - 69
BOTANICA	148 - 149
CERLER	176 - 181
COTTO BRICK	50 - 51
COTTO NATURE	70 - 73
COTTAGE	30 - 33
D'ANTICATTO	58 - 59
D'ANTICATTO DECOR	60 - 63
FUEGO	34 - 37
FUEGO DECOR	38 - 43
HERITAGE CLAY	84 - 95
LANDS	22 - 29
LIMESTONE	116 - 117
NATURA	150 - 153
NATUR-TECH	136 - 137
NATUR TRANSIT 2.0	132 - 135
OLIMPO	120 - 121
ORION	108 - 109
PARK	156 - 157
PIEDRAS DEL BRUC	126 - 127
PIEMONTE	74 - 77
PIRINEOS	128 - 129
POSETS	122 - 125
SAONA	172 - 175
SARSEN STONE	96 - 107
SHERWOOD	138 - 145
RETRO	158 - 159
TECH-GEO	130 - 131
TECH-LAND	78 - 79
TECH-LAND DECOR	80 - 83
TOSCANA	182 - 187
UNIKA	52 - 55
UNIKA DECOR	56 - 57
ZERMATT	146 - 147

## REVESTIMIENTO

WALL TILE	
AUSTRAL	218
CAPRI	207
COOL	204 - 205
EVOKE	216 - 217
FIKA	214 - 215
FRAME	232 - 233
HERITAGE CLAY	84 - 95
HERITAGE CLAY REV.	190 - 195
LINEAGE	208 - 213
LIVERPOOL	206
MARE NOSTRUM	238 - 239
PIASTRELLA MIX	222 - 223
POOL	224 - 225
SARSEN STONE	96 - 107
SARSEN STONE REV.	196 - 201
STOW / STOW MIX	226 - 227
TABARCA	228 - 231
TEMPO	234 - 237
VEGA	219
WABI SABI	202 - 203
ZELLIGE	220 - 221

## DECORADOS

DECORATES	
FIORANO	48
VENICE	48
VERSILIA	74 - 77

# Índice Tipologías

TIPOLOGY INDEX

## TIPOLOGÍA

TIPOLOGY							
<b>BARRO COTTO</b>		<b>HIDRÁULICO HYDRAULIC</b>	<b>MIX COLOR BLENDED</b>	<b>PIEDRA STONE</b>			
AMERICAN DECOR	66 - 67	AMERICAN DECOR	66 - 67	CAPRI	207	ALMA	110 - 111
ARGILE	44 - 47	ANIMA DECOR	114 - 115	EVOKE	216 - 217	ALPES	118 - 119
ARGILE DECOR	48 - 49	ARGILE DECOR	48 - 49	FIKA	214 - 215	ANIMA	112 - 115
BOSTON	64 - 65	D'ANTICATTO DECOR	60 - 63	LIVERPOOL	206	ARTIES	162 - 169
BOSTON BRICK	68 - 69	FRAME	232 - 233	MARE NOSTRUM	238 - 239	CERLER	178 - 181
COTTO BRICK	50 - 51	FUEGO DECOR	38 - 43	PIASTRELLA MIX	222 - 223	HERITAGE CLAY	84 - 95
COTTO NATURE	70 - 73	TABARCA	228 - 231	POOL	224 - 225	HERITAGE CLAY REV.	190 - 195
COTTAGE	30 - 33	TECH-LAND DECOR	80 - 83	STOW / STOW MIX	226 - 227	LIMESTONE	116 - 117
D'ANTICATTO	58 - 59	TEMPO DECOR	236 - 237	ZELLIGE	220 - 221	NATUR TRANSIT 2.0	132 - 135
D'ANTICATTO DECOR	60 - 63	UNIKA DECOR	56 - 57	ZERMATT	146 - 147	OLIMPO	120 - 121
FUEGO	34 - 37					ORION	108 - 109
FUEGO DECOR	38 - 43					PIEDRAS DEL BRUC	126 - 127
LANDS	22 - 29					PIRINEOS	128 - 129
PIEMONTE	74 - 77					POSETS	122 - 125
TECH-LAND	78 - 79					SAONA	170 - 175
TECH-LAND DECOR	80 - 83					SARSEN STONE	96 - 107
TOSCANA	182 - 187					SARSEN STONE REV.	196 - 201
UNIKA	52 - 55					TECH-GEO	130 - 131
						TEMPO	234 - 237
<b>BRICK BRICK</b>		<b>MADERA WOOD</b>		<b>PAVIMENTO DRENANTE</b>		<b>PISCINAS POOLS</b>	
BOSTON BRICK	68 - 69	ALQUÉZAR	154 - 155	DRAINING FLOOR TILE		PIRINEOS	128 - 129
CAPRI	207	BOTANICA	148 - 149	NATUR-TECH	136 - 137	POOL	224 - 225
COOL	204 - 205	NATURA	150 - 153				
COTTO BRICK	50 - 51	NATUR-TECH	136 - 137	<b>PAVIMENTO PODOTACTIL</b>			
EVOKE	216 - 217	PARK	156 - 157	PODOTACTILE FLOOR TILE			
FUEGO	34 - 43	RETRO	158 - 159	NATUR 2.0 TRANSIT	132 - 135		
LINEAGE	208 - 213	SHERWOOD	138 - 145				
LIVERPOOL	206	ZERMATT	146 - 147	<b>PAVIMENTO INDUSTRIAL</b>			
PIASTRELLA MIX	222 - 223			INDUSTRIAL FLOOR TILE			
TABARCA	228 - 231			NATUR 2.0 TRANSIT	132 - 135		
WABI SABI	202 - 203						
ZELLIGE	220 - 221						

# Índice Formatos

SIZES INDEX · INDEX DES FORMATS



## 160 x 160 RECT. · 64" x 64"

SARSEN STONE	102 - 103
--------------	-----------

## 120 x 120 RECT. · 48" x 48"

HERITAGE CLAY	90 - 91
---------------	---------

SARSEN STONE	102 - 103
--------------	-----------

## 90 x 90 RECT. 35,4" x 35,4"

ALMA	110 - 111
------	-----------

ANIMA	112 - 115
-------	-----------

ORION	108 - 109
-------	-----------

## 60 x 60 · 23,6" x 23,6"

COTTAGE	30 - 31
---------	---------

COTTAGE DECOR	32 - 33
---------------	---------

HERITAGE CLAY	90 - 91
---------------	---------

LANDS	22 - 29
-------	---------

LIMESTONE	116 - 117
-----------	-----------

SARSEN STONE	102 - 103
--------------	-----------

## 45 x 45 · 17,7" x 17,7"

ARGILE	44 - 45
--------	---------

FUEGO	34 - 35
-------	---------

LANDS	22 - 29
-------	---------

## 36 x 36 · 14" x 14"

BOSTON	64 - 65
--------	---------

COTTO NATURE	70 - 73
--------------	---------

PIEMONTE	74 - 77
----------	---------

POSETS	124 - 125
--------	-----------

## 33,3 x 33,3 · 13,1" x 13,1"

CERLER	180 - 181
--------	-----------

TOSCANA	186 - 187
---------	-----------

## 30 x 30 · 11,8" x 11,8"

COTTAGE	30 - 31
---------	---------

COTTO NATURE	70 - 71
--------------	---------

TECH LAND	78 - 79
-----------	---------

LIMESTONE	116 - 117
-----------	-----------

## 22,5 x 22,5 · 8" x 8"

AMERICAN DECOR	66 - 67
----------------	---------

ANIMA ANTISLIP	114 - 115
----------------	-----------

ARGILE	44 - 45
--------	---------

ARGILE DECOR	48 - 49
--------------	---------

BOSTON	64 - 65
--------	---------

D'ANTICATTO	58 - 59
-------------	---------

D'ANTICATTO DECOR	60 - 63
-------------------	---------

FUEGO	34 - 35
-------	---------

FUEGO DECOR	38 - 43
-------------	---------

LANDS	22 - 29
-------	---------

TABARCA	228 - 231
---------	-----------

TECH GEO	130 - 131
----------	-----------

TECH LAND	78 - 79
-----------	---------

TECH LAND DECOR	80 - 83
-----------------	---------

TEMPO	236 - 237
-------	-----------

UNIKA	52 - 53
-------	---------

UNIKA DECOR	56 - 57
-------------	---------

## 10 x 10 · 4" x 4"

FIKA	214 - 215
------	-----------

POOL	224 - 225
------	-----------

STOW/STOW MIX	226 - 227
---------------	-----------

## 18 x 18 · 7" x 7"

COTTO NATURE	72 - 73
--------------	---------

MARE NOSTRUM	238 - 239
--------------	-----------

PIEMONTE	76 - 77
----------	---------

POSETS ANTISLIP	124 - 125
-----------------	-----------

## 15 x 15 · 6" x 6"

ARGILE	44 - 47
--------	---------

HERITAGE CLAY	90 - 91
---------------	---------

HERITAGE CLAY REV.	194 - 195
--------------------	-----------

PIRINEOS	128 - 129
----------	-----------

SARSEN STONE	102 - 103
--------------	-----------

SARSEN STONE REV.	200 - 201
-------------------	-----------

## 11 x 11 · 4,3" x 4,3"

TEMPO	236 - 237
-------	-----------

## 30,5 x 30,5 ENM. · 12" x 12"

FIKA	214 - 215
------	-----------

POOL	224 - 225
------	-----------

## 20 x 20 · 8" x 8"

NATUR TRANSIT 2.0	132 - 135
-------------------	-----------



## 60 x 120 RECT. · 23,6" x 48"

ALPES	118 - 119
-------	-----------

HERITAGE CLAY	90 - 95
---------------	---------

OLIMPO	120 - 121
--------	-----------

POSETS	122 - 123
--------	-----------

SARSEN STONE	102 - 107
--------------	-----------

## 40 x 120 RECT. · 16" x 48"

AUSTRAL	218
---------	-----

VEGA	219
------	-----

## 60 x 90 · 24" x 35,4"

HERITAGE CLAY	94 - 95
---------------	---------

SARSEN STONE	106 - 107
--------------	-----------

## 36 x 72 · 14" x 28"

POSETS	124 - 125
--------	-----------

## 45 x 67,5 · 17,7" x 26,5"

PIEDRAS DEL BRUC	126 - 127
------------------	-----------

## 22 x 67,5 · 17,7" x 26,5"

PIEDRAS DEL BRUC	126 - 127
------------------	-----------

## 33 x 66,5 · 13" x 26,5"

PIRINEOS	128 - 129
----------	-----------

## 30,3 x 61,3 · 11,9" x 24,1"

ARTIES	166 - 169
--------	-----------

SAONA	174 - 175
-------	-----------

## 30 x 60 · 11,8" x 23,6"

HERITAGE CLAY	90 - 91
---------------	---------

SARSEN STONE	102 - 103
--------------	-----------

## 21 x 60 · 8" x 23,6"

RETRO	158 - 159
-------	-----------

## 20 x 60 · 8" x 24"

FIKA	214 - 215
------	-----------

STOW/STOW MIX	226 - 227
---------------	-----------

## 25 x 50 ENM. · 10" x 20"

CAPRI	207
-------	-----

## 22,5 x 45 · 8,8" x 17,7"

ARGILE	44 - 45
--------	---------

BOSTON	64 - 65
--------	---------

D'ANTICATTO	58 - 59
-------------	---------

LANDS	22 - 29
-------	---------

UNIKA	52 - 53
-------	---------

## 22,5 x 33 · 8,8" x 13"

TECH LAND	78 - 79
-----------	---------

TECH GEO	130 - 131
----------	-----------

## 20 x 30 · 8" x 13"

NATUR TRANSIT 2.0	132 - 135
-------------------	-----------

## 10 x 20 · 4" x 8"

FIKA	214 - 215
------	-----------



## 30 x 180 RECT. · 11,8" x 72"

SHERWOOD	144 - 145
----------	-----------

## 25 x 150 RECT. · 10" x 60"

BOTÁNICA	148 - 149
----------	-----------

NATURA	150 - 151
--------	-----------

SHERWOOD	142 - 143
----------	-----------

ZERMATT	146 - 147
---------	-----------

## 20 x 120 RECT. · 8" x 48"

ALQUÉZAR	154 - 155
----------	-----------

NATURA	152 - 153
--------	-----------

PARK	156 - 157
------	-----------

SHERWOOD	142 - 143
----------	-----------

## 20 x 90/2,6 · 8" x 35,4/1"

NATUR-TECH	136 - 137
------------	-----------

## 7 x 60 · 3" x 24"

COTTO BRICK	50 - 51
-------------	---------

RETRO	158 - 159
-------	-----------

## 20 x 45/2,6 · 8" x 17,7/1"

NATUR-TECH	136 - 137
------------	-----------

## 7 x 45 · 3" x 17,7"

MARE NOSTRUM	238 - 239
--------------	-----------

## 7 x 40 · 3" x 16"

WABI SABI	202 - 203
-----------	-----------

## 5 x 30 · 2" x 12"

COOL	204 - 205
------	-----------

LIVERPOOL	206
-----------	-----

## 6,5 x 26 · 2,5" x 10"

EVOKE	216 - 217
-------	-----------

## 6,5 x 20 · 2,5" x 8"

HERITAGE CLAY	90 - 91
---------------	---------

HERITAGE CLAY REV.	194 - 195
--------------------	-----------

LINEAGE	212 - 213
---------	-----------

## 6,2 x 25 · 2,5" x 10"

ZELLIGE	220 - 221
---------	-----------

## 6,5 x 25 · 2,5" x 10"

BOSTON BRICK	68 - 69
--------------	---------

CAPRI	207
-------	-----

FUEGO BRICK	36 - 37
-------------	---------

## 5 x 25 · 2" x 10"

PIASTRELLA MIX	222 - 223
----------------	-----------

SARSEN STONE	102 - 103
--------------	-----------

SARSEN STONE REV.	200 - 201
-------------------	-----------

## MODULAR MODULAR

ARGILE	44 - 45
--------	---------

BOSTON	64 - 65
--------	---------

COTTO NATURE	70 - 73
--------------	---------

D'ANTICATTO	58 - 59
-------------	---------

HERITAGE CLAY	90 - 91
---------------	---------

LANDS	22 - 29
-------	---------

LIMESTONE	116 - 117
-----------	-----------

PIEMONTE	70 - 77
----------	---------

POSETS ANTISLIP	124 - 125
-----------------	-----------

SARSEN STONE	102 - 103
--------------	-----------

TECH-GEO	130 - 131
----------	-----------

TECH-LAND	78 - 79
-----------	---------

UNIKA	52 - 53
-------	---------

## ESTRELLA STAR

ARGILE	46 - 47
--------	---------

COTTAGE	30 - 31
---------	---------

LANDS	22 - 29
-------	---------

LIMESTONE	116 - 117
-----------	-----------

PIEMONTE	74 - 75
----------	---------

TECH-LAND DECOR	82 - 83
-----------------	---------

UNIKA	54 - 55
-------	---------

## PROVENZAL PROVENZAL

MARE NOSTRUM	238 - 239
--------------	-----------

## CRUZ CROSS



ARGILE	46 - 47
--------	---------

||
||
||

# Índice Acabados

FINISHES INDEX · INDEX DES FINITIONS

## ANTIDESLIZAMIENTO ANTISLIP

 <b>CLASE I - R9</b> UNE-EN-16165 · ANEXO C - B	
ALMA	110 - 111
ALPES	118 - 119
ALQUÉZAR	154 - 155
ANIMA	112 - 115
ARGILE	44 - 47
ARGILE DECOR	48 - 49
BOSTON BRICK	68 - 69
BOTANICA	148 - 149
COTTO NATURE	72 - 73
COTTAGE	30 - 31
COTTAGE DECOR	32 - 33
FUEGO	34 - 35
HERITAGE CLAY	90 - 91
HERITAGE CLAY REV.	190 - 195
LANDS	22 - 29
LIMESTONE	116 - 117
NATURA	150 - 153
OLIMPO	120 - 121
ORION	108 - 109
PARK	156 - 157
PIEDRAS DEL BRUC	126 - 127
PIEMONTE	76 - 77
PIRINEOS	128 - 129
POOL	224 - 225
POSETS	122 - 123
SARSEN STONE	102 - 105
SARSEN STONE REV.	196 - 201
SHERWOOD	142 - 145
ZERMATT	146 - 147
 <b>CLASE II - R10</b> UNE-EN-16165 · ANEXO C - B	
ARGILE DECOR	48 - 49
COTTAGE	32 - 33
COTTO BRICK	50 - 51
FUEGO	34 - 37
FUEGO BRICK	36 - 37
FUEGO DECOR	38 - 43
LANDS	22 - 29
LIMESTONE	116 - 117
OLIMPO	120 - 121
UNIKA	52 - 57
UNIKA DECOR	56 - 57

 <b>CLASE III - R10</b> UNE-EN-16165 · ANEXO C - B	
PIEMONTE	74 - 75
 <b>CLASE III - R11</b> UNE-EN-16165 · ANEXO C - B	
ALMA	110 - 111
ALPES	118 - 119
ALQUÉZAR	154 - 155
ANIMA	112 - 115
ARGILE	44 - 45
ARTIES	162 - 169
BOTANICA	148 - 149
CERLER	178 - 181
COTTO NATURE	70 - 71
COTTAGE	30 - 31
D'ANTICATTO	58 - 59
D'ANTICATTO DECOR	60 - 63
FUEGO	34 - 35
HERITAGE CLAY	90 - 95
LANDS	22 - 29
LIMESTONE	116 - 117
NATURA	150 - 153
NATUR-TECH	136 - 137
ORION	108 - 109
PARK	156 - 157
POOL	224 - 225
POSETS	122 - 125
RETRO	158 - 159
SAONA	172 - 175
SARSEN STONE	102 - 107
SHERWOOD	142 - 145
TECH-GEO	130 - 131
TECH-LAND	78 - 79
TECH-LAND DECOR	80 - 83
TOSCANA	182 - 187
ZERMATT	146 - 147

 <b>CLASE III - R12</b> UNE-EN-16165 · ANEXO C - B	
AMERICAN DECOR	66 - 67
ANIMA	114 - 115
BOSTON	64 - 65
BOSTON BRICK	68 - 69
NATUR TRANSIT 2.0	132 - 135
PIEDRAS DEL BRUC	126 - 127
 <b>CLASE III - R13</b> UNE-EN-16165 · ANEXO C - B	
PIRINEOS	128 - 129
 <b>CLASE B</b> UNE-EN-16165 · ANEXO A	
ALPES	118 - 119
ALQUÉZAR	154 - 155
BOTANICA	148 - 149
NATURA	150 - 153
OLIMPO	120 - 121
PARK	156 - 157
 <b>CLASE C</b> UNE-EN-16165 · ANEXO A	
AMERICAN DECOR	66 - 67
ANIMA	112 - 115
ARGILE	44 - 45
BOSTON	64 - 65
BOSTON BRICK	68 - 69
D'ANTICATTO	58 - 59
D'ANTICATTO DECOR	60 - 63
NATUR TRANSIT 2.0	132 - 135
PIEDRAS DEL BRUC	126 - 127
PIEMONTE	74 - 77
PIRINEOS	128 - 129
TECH-LAND	78 - 79
TECH-LAND DECOR	80 - 83

## RECTIFICADO RECTIFIED

ALMA	110 - 111
ALPES	118 - 119
ALQUÉZAR	154 - 155
ANIMA	112 - 115
AUSTRAL	218
BOTANICA	148 - 149
HERITAGE CLAY	90 - 95
NATURA	150 - 153
NATUR-TECH	136 - 137
OLIMPO	120 - 121
ORION	108 - 109
PARK	156 - 157
PIRINEOS	128 - 129
POSETS	122 - 125
SARSEN STONE	96 - 107
SHERWOOD	142 - 145
VEGA	219
ZERMATT	146 - 147

## ESPESOR PAV. THICKNESS FLOOR

<b>26 MM ESPESOR</b> 1" THICKNESS	
NATUR-TECH	136 - 137
<b>20 MM ESPESOR</b> 0,8" THICKNESS	
NATUR TRANSIT 2.0	132 - 135
HERITAGE CLAY	94 - 95
SARSEN STONE	106 - 107
<b>14 MM ESPESOR</b> 0,5" THICKNESS	
TECH-GEO	130 - 131
TECH-LAND	78 - 83
<b>12 MM ESPESOR</b> 0,4" THICKNESS	
ARGILE	44 - 45
COTTAGE	30 - 31
FUEGO	34 - 43
LANDS	22 - 29
LIMESTONE	116 - 117
PIEDRAS DEL BRUC	126 - 127
RETRO	158 - 159

# Índice Piezas Especiales

SPECIAL PIECES INDEX · INDEX DES PIÈCES SPÉCIALES

## PELDAÑO BLOCK BLOCK STEP



<b>120 x 33/1,4</b> · 48" x 13,4/0,5"	
ARTIES	162 - 169
HERITAGE CLAY	84 - 95
SAONA	172 - 175
SARSEN STONE	96 - 107
SHERWOOD	142 - 145

## PELDAÑO ANGULAR ANGULAR STEP



<b>120 x 32/3</b> · 48" x 12,5/1"	
ALPES	118 - 119
ALQUÉZAR	154 - 155
ANIMA	112 - 115
BOTANICA	148 - 149
NATURA	150 - 153
OLIMPO	120 - 121
PARK	156 - 157
POSETS	122 - 125

<b>60 x 32/3</b> · 23,6" x 12,5/1"	
ALPES	118 - 119
ALQUÉZAR	154 - 155
ANIMA	112 - 115
BOTANICA	148 - 149
NATURA	150 - 153
OLIMPO	120 - 121
PARK	156 - 157
POSETS	122 - 125

<b>60 x 32/3</b> · 23,6" x 12,5/1"	
ALPES	118 - 119
ALQUÉZAR	154 - 155
ANIMA	112 - 115
BOTANICA	148 - 149
NATURA	150 - 153
OLIMPO	120 - 121
PARK	156 - 157
POSETS	122 - 125

<b>67,5 x 32/3</b> · 26,5" x 12,5/1"	
PIEDRAS DEL BRUC	126 - 127

<b>66,5 x 32/3</b> · 26,5" x 12,5/1"	
NATUR TRANSIT 2.0	132 - 135
PIRINEOS	128 - 129

<b>32 x 32/3</b> · 12,5" x 12,5/1"	
RETRO	158 - 159

## REMATE ANGULAR ANGULAR REMAT



<b>20 x 90/2,6</b> · 8" x 35,4/1"	
<b>20 x 45/2,6</b> · 8" x 17,7/1"	
NATUR TECH	136 - 137

## PELDAÑO RECTO STRAIGHT STEP



<b>150 x 33/3</b> · 60" x 13/1"	
SHERWOOD	142 - 145
ZERMATT	146 - 147

<b>120 x 33/3</b> · 48" x 13/1"	
ALMA	110 - 111
HERITAGE CLAY	84 - 95
LIMESTONE	116 - 117
ORION	108 - 109
SARSEN STONE	96 - 107
SHERWOOD	142 - 145
ZERMATT	146 - 147

<b>60 x 33/3</b> · 23,6" x 13/1"	
ALMA	110 - 111
LIMESTONE	116 - 117
HERITAGE CLAY	84 - 95
SARSEN STONE	96 - 107
SHERWOOD	142 - 145
ORION	108 - 109
ZERMATT	146 - 147

<b>45 x 32/3</b> · 17,7" x 12,5/1"	
UNIKA	52 - 55

## PELD. RECT. CON GOTERÓN STRAIGHT STEP WITH DRIP EDGE



<b>61,3 x 32/3</b> · 24" x 12,5/1"	
ARTIES	162 - 169
SAONA	172 - 175

<b>33,3 x 33,3/3</b> · 13,1" x 12,5/1"	
CERLER	178 - 181

## CANALETAS DRAINAGE CHANNELS



NATUR TRANSIT 2.0	132 - 135
-------------------	-----------

## PZS. PODOTÁCTILES TACTILE TILES

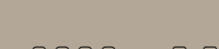

NATUR TRANSIT 2.0	132 - 135
-------------------	-----------

## PELDAÑO CURVO CURVED STEP



<b>60 x 33/4</b> · 23,6" x 13/1,5"	
COTTAGE	30 - 31

<b>45 x 33/4</b> · 17,7" x 13/1,5"	
ARGILE	44 - 45
FUEGO	34 - 35
LANDS	22 - 29

<b>36 x 33/4</b> · 14" x 13/1,5"	
BOSTON	64 - 65
COTTO NATURE	70 - 73
NATUR TRANSIT 2.0	132 - 135
PIEMONTE	74 - 77

<b>33,3 x 33,3/4</b> · 13" x 13/1,5"	
TOSCANA	182 - 187

<b>30 x 33/4</b> · 11,8" x 13/1,5"	
COTTO NATURE	70 - 73
TECH LAND	78 - 79

<b>22,5 x 33/4</b> · 8,8" x 13/1,5"	
BOSTON	64 - 65
D'ANTICATTO	58 - 59
NATUR TRANSIT 2.0	132 - 135
TECH GEO	130 - 131

 <b>VIERTEAGUAS GUTTER</b>	
BOSTON	64 - 65
CERLER	178 - 181
COTTO NATURE	70 - 71
FUEGO	34 - 35
LIMESTONE	116 - 117
NATUR 2.0 TRANSIT	132 - 135
TECH-LAND	78 - 79
TEMPO	234 - 237
TOSCANA	182 - 187

 <b>PASAMANOS HANDRAILS</b>	
CERLER	178 - 181
TOSCANA	182 - 187

## BORDE PISCINA POOL EDGE



ARTIES	162 - 169
HERITAGE CLAY	84 - 95
ORION	108 - 109
PIEDRAS DEL BRUC	126 - 127
PIRINEOS	128 - 129
POSETS	122 - 125
SAONA	172 - 175
SARSEN STONE	96 - 107
TECH LAND	78 - 79

## DESBORDANTE OVERFLOW



ALPES	118 - 119
ARTIES	162 - 169
HERITAGE CLAY	84 - 95
ORION	108 - 109
PIEDRAS DEL BRUC	126 - 127
SAONA	172 - 175
SARSEN STONE	96 - 107

## REJILLA GRATING



ALPES	118 - 119
ARTIES	162 - 169
HERITAGE CLAY	84 - 95
ORION	108 - 109
PIEDRAS DEL BRUC	126 - 127
SAONA	172 - 175
SARSEN STONE	96 - 107

## PZS. ESPECIALES SPECIAL PIECES CUBRECANTO, MEDIA CAÑA Y COMPLEMENTOS



ARTIES	162 - 169
HERITAGE CLAY	84 - 95
NATUR TRANSIT 2.0	132 - 135
ORION	108 - 109
POOL	224 - 225
SAONA	172 - 175
SARSEN STONE	96 - 107

UNA VISIÓN INTEGRAL DE LOS ESPACIOS DONDE LA CERÁMICA REDEFINE EL DISEÑO Y LA FUNCIONALIDAD.

A COMPREHENSIVE VIEW OF THE SPACES WHERE CERAMICS REDEFINE DESIGN AND FUNCTIONALITY.

UNE VISION GLOBALE DES ESPACES OÙ LA CÉRAMIQUE REDÉFINIT LE DESIGN ET LA FONCTIONNALITÉ.

REVESTIMIENTOS  
PASTA BLANCA  
WALL TILES OF WHITE BODY

DORMITORIO  
BEDROOM

BAÑO  
BATHROOM

COCINA  
KITCHEN

PAVIMENTOS  
ANTIDESLIZANTES  
CLASE III - R11  
ANTISLIP FLOORS  
CLASS III - R11

SISTEMAS  
DE CORONACIÓN  
DE PISCINAS  
ANGULAR STEP

PORCELÁNICO PARA  
VASO DE PISCINA  
SWIMMING POOL LINING

PELDAÑOS  
STEPS

SUELO PORCELÁNICO CLASE I - R9  
PORCELAIN FLOOR TILE CLASS I - R9

TERRAZA  
TERRACE

SALÓN  
LIVINGROOM

## Usos y aplicaciones de la cerámica

USES AND APPLICATIONS OF TILES  
USAGES ET APPLICATIONS DE LA CÉRAMIQUE

# Simbología

SYMBOLOLOGY · SIMBOLOGIE

<b>P</b> <b>PORCELÁNICO</b> Porcelain Tile Grès cérame	<b>SIN MANTENIMIENTO</b> No maintenance Sans entretien	<b>SUPERFICIE MATE</b> Matt surface Surface mate	<b>ENMALLADO</b> On a mesh Céramique en treillis
<b>PE</b> <b>GRES EXTRUSIONADO PORCELÁNICO</b> Porcelain extruded tile Grès cérame extrudé	<b>RESISTENCIA AL RAYADO</b> Scratch resistance Résistance aux rayures	<b>SUPERFICIE SATINADO</b> Satin finish Surface satinée	<b>VOLUMEN</b> Volume Volume
<b>PAVIMENTO DE INTERIOR</b> Indoor floor tiles Revêtement de sol intérieur	<b>RESISTENTE AL DESGASTE</b> Wear resistance Résistant à l'usure	<b>SUPERFICIE BRILLO</b> Surface brightness / glossy Surface brillante	<b>DESTONIFICADO ARMONIOSO</b> Controlled destonification Détonification harmonieuse
<b>PAVIMENTO EXTERIOR</b> Outdoor floor tile Revêtement de sol extérieur	<b>RESISTENTE A LA HELADA</b> Frost proof Résistant au gel	<b>MODULARIDAD</b> Modularity Modularité	<b>BORDES Y SUPERFICIE IRREGULAR</b> Irregular Edges and Surface Bords et surface irréguliers
<b>REVESTIMIENTO</b> Wall tile Revêtement	<b>RESISTENCIA A ÁCIDOS Y BASES</b> Resistance to acids and bases Résistance aux acides et aux bases	<b>RECTIFICADO</b> Rectified Rectifié	<b>NÚMERO DE GRÁFICAS</b> Number of graphs Nombre de graphiques
<b>SPECIAL ORDER (MINIMUM 4 WEEKS LEAD TIME)</b> BAJO PEDIDO (MÍNIMO 4 SEMANAS) SUR COMMANDE (DÉLAI MINIMUM DE 4 SEMAINES)	<b>SERIES NOVEDADES</b> New series Nouvelles séries		

## CARACTERÍSTICAS TÉCNICAS / Technical characteristics / Caractéristiques techniques

<b>FUERZA DE ROTURA</b> Breaking strength Résistance à la rupture	<b>ANTIDESLIZANTE TORTUS</b> Antislip Antidérapant	<b>MANCHAS</b> Staining Taches	<b>ABSORCIÓN</b> Water absorption Absorption
<b>CARGA DE ROTURA</b> Breaking Charge de rupture	<b>ANTIDESLIZANTE</b> UNE-EN-16165 ANEXO C-B Antislip Antidérapant	<b>DILATACIÓN</b> Dilatation Dilatation	<b>ESPESOR</b> Thickness Épaisseur
<b>RESISTE EL DESGASTE</b> Wear resistance Résistant à l'usure	<b>ANTIDESLIZANTE</b> UNE-EN-16165 ANEXO A Antislip Antidérapant	<b>RESISTE LA FLEXIÓN</b> Bending resistance Résiste à la flexion	<b>ANTIHIELO</b> Antifreeze Antigel
<b>RESISTE EL RAYADO</b> Scratch resistance Résistance aux rayures			

## TIPOLOGÍA DE FABRICACIÓN / Type of manufacture / Typologie de fabrication

<b>EXTRUSIONADO PORCELÁNICO</b> EXTRUDED PORCELAIN TILE EXTRUDÉ PORCELANIQUE	<b>PORCELÁNICO</b> PORCELAIN TILE Porcelain tile Grès cérame	<b>PRODUCTO SE VENDE POR PIEZA</b> This product is sold per piece Produit vendu à la pièce
<b>PORCELÁNICO RECTIFICADO</b> RECTIFIED PORCELAIN TILE GRÈS CÉRAMÉ RECTIFIÉ	<b>PASTA BLANCA</b> White body Pâte blanche	<b>PRODUCTO SE VENDE POR M2</b> This product is sold per sqm Produit vendu au m <sup>2</sup>
	<b>ANTIBACTERIANO</b> Antibacterial Antibactérien	<b>GARANTÍA DE CALIDAD</b> QUALITY GUARANTEE GARANTIE DE QUALITÉ
		<b>MADE IN SPAIN</b>

# Uso de Catálogo

USE OF CATALOGUE · UTILISATION DU CATALOGUE



<b>1 NOMBRE DE LA SERIE</b> Name of the serie Nom de la série	<b>7 AMBIENTES DE LA SERIE</b> Environments series Ambiances de la série	<b>13 FORMATOS DISPONIBLES</b> Available sizes Formats disponibles
<b>2 SERIES NOVEDADES</b> New series Nouvelles séries	<b>8 REFERENCIA DEL AMBIENTE</b> Environment reference Référence de l'environnement	<b>45 x 45</b> TAMAÑO EN CENTÍMETROS Size centimeters Dimensions en centimètres
<b>3 ANTIDESLIZAMIENTO</b> Antislip Antidérapant	<b>9 PIEZAS ESPECIALES</b> Special pieces Pièces spéciales	<b>(G 73)</b> CÓDIGO DE PRECIO Price code Code de prix
<b>4 CARACTERÍSTICAS TÉCNICAS</b> Technical characteristics Caractéristiques techniques	<b>10 NÚMERO DE PÁGINA</b> Page number Numéro de page	<b>17,7" x 17,7"</b> TAMAÑO EN PULGADAS Size inches Dimensions en pouces
<b>5 COLORES DISPONIBLES</b> Color typology Couleur de typologie	<b>11 PIEZAS DE LA SERIE</b> Serie pieces Pièces de la série	<b>12 mm.</b> ESPESOR Thickness Épaisseur
<b>6 QR DE LA SERIE</b> QR of the serie QR de la série	<b>12 NÚMERO DE CARAS O DISEÑOS DISPONIBLES</b> Page number Numéro de page	<b>14 TIPOLOGÍA DE FABRICACIÓN</b> Type of manufacture Typologie de fabrication



# Pavimento

floor tiles



## COLECCIONES · COLLECTIONS

### BARRO · COTTO

AMERICAN	66 - 67
ARGILE	44 - 49
BOSTON	64 - 65
BOSTON BRICK	68 - 69
COTTAGE	30 - 33
COTTO BRICK	50 - 51
COTTO NATURE	70 - 73
D'ANTICATTO	58 - 63
FUEGO	34 - 43
LANDS	22 - 29
PIEMONTE	74 - 77
TECH-LAND	78 - 83
UNIKA	52 - 57

### PIEDRA · STONE

ALMA	110 - 111
ALPES	118 - 119
ANIMA	112 - 113
ANIMA ANTISLIP	114 - 115
HERITAGE CLAY	84 - 95
LIMESTONE	116 - 117
NATUR TRANSIT 2.0	132 - 135
OLIMPO	120 - 121
ORION	108 - 109
PIEDRAS DEL BRUC	126 - 127
PIRINEOS	128 - 129
POSETS	122 - 123
POSETS ANTISLIP	124 - 125
SARSEN STONE	96 - 107
TECH-GEO	130 - 131

### MADERA · WOOD

ALQUÉZAR	154 - 155
BOTANICA	148 - 149
NATURA	150 - 153
NATUR·TECH	136 - 137
PARK	156 - 157
RETRO	158 - 159
SHERWOOD	138 - 145
ZERMATT	146 - 147
<b>PROJECT ZERO</b>	
ARTIES	162 - 169
CERLER	176 - 181
TOSCANA	182 - 187
SAONA	170 - 175





Lands Loees 45x45 - Lands Loees 22,5x45 - Lands Loees 22,5x22,5



**LANDS, la materia del barro reinterpretada con elegancia actual.**  
*LANDS, the essence of clay reinterpreted with contemporary elegance.*

**LANDS**



NATUCER  
*cerámica natural*

NEW  
2026

# LANDS

LANDS reinterpreta el barro como materia esencial desde una mirada actual y refinada. Sus superficies ponen en valor lo artesanal y lo natural, transformando la tradición en un lenguaje contemporáneo lleno de sobriedad y carácter. Una colección que aporta autenticidad y equilibrio a espacios con identidad propia.

LANDS reinterprets clay as an essential material through a refined, contemporary perspective. Its surfaces highlight the handcrafted and the natural, transforming tradition into a modern language defined by sobriety and character. A collection that brings authenticity and balance to spaces with their own identity.

NATUCER  
cerámica natural



Pav. / Floor: Lands Loes Antislip 45x45 - Peldaño Curvo Lands Loes Antislip 45x33/4  
Vaso Piscina / Pool Basin: Square Fiorano 15x15



Pav. / Floor: Lands Desert Antislip 45x45 - Lands Desert Antislip 22,5x45 - Lands Desert Antislip 22,5x22,5 - Peldaño Curvo Lands Desert Antislip 45x33/4



Pav. / Floor: Lands Loees Antislip 45x45 - Lands Loees Antislip 22,5x45 - Lands Loees Antislip 22,5x22,5 - Peldaño Curvo Lands Loees Antislip 45x33/4



**LANDS KAOLIN**  
**LANDS KAOLIN ANTISLIP**  
\* 60 x 60 - 23,6" x 23,6" - CLASE I - R9  
\* STAR & CROSS 15,5 x 15,5 - 6" x 6" - CLASE II - R10



**LANDS DESERT**  
**LANDS DESERT ANTISLIP**  
\* 60 x 60 - 23,6" x 23,6" - CLASE I - R9  
\* STAR & CROSS 15,5 x 15,5 - 6" x 6" - CLASE II - R10



**LANDS JASPER**  
**LANDS JASPER ANTISLIP**  
\* 60 x 60 - 23,6" x 23,6" - CLASE I - R9  
\* STAR & CROSS 15,5 x 15,5 - 6" x 6" - CLASE II - R10



**LANDS LOEES**  
**LANDS LOEES ANTISLIP**  
\* 60 x 60 - 23,6" x 23,6" - CLASE I - R9  
\* STAR & CROSS 15,5 x 15,5 - 6" x 6" - CLASE II - R10

\* **Gráfica diferente + Bordes irregulares**  
Different graphics + Irregular Edges

\* 24  
11 x 22,5 (G 80)  
11 x 22,5 (G 80) ANTISLIP  
4,3" x 8,8"   
± 10 mm.



Pav. / Floor: Lands Loees Antislip 11x22,5 - Peldaño Curvo Lands Loees Antislip 45x33/4

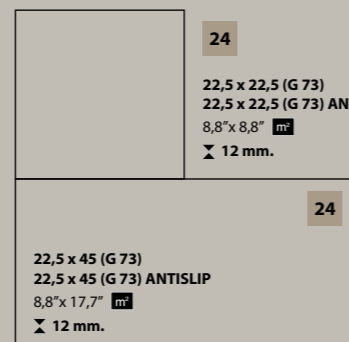
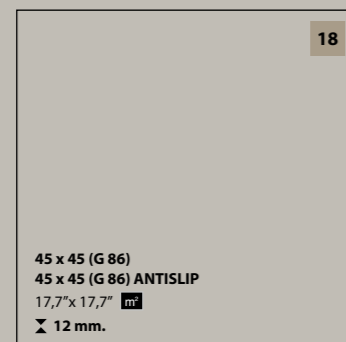

PIEZAS ESPECIALES - SPECIAL PIECES

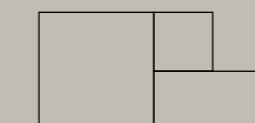
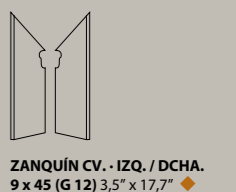
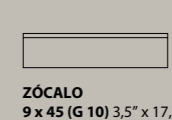
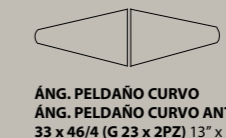

**Cada caja contiene:**  
3 piezas de 45x45  
3 piezas de 22,5x45  
3 piezas de 22,5x22,5

**Each box contains:**  
3 piezas 17,7"x17,7"  
3 piezas 8,8"x17,7"  
3 piezas 8,8"x8,8"



Pav. / Floor: Lands Kaolin 60x60 - Peldaño Curvo Lands Kaolin 45x33/4



Pav. / Floor: Lands Desert 60x60



LANDS KAOLIN 60 x 60 (G 79) 23,6" x 23,6" **m²** 18  
x 12 mm.



LANDS LOEES 60 x 60 (G 79) 23,6" x 23,6" **m²** 18  
x 12 mm.



LANDS ANDES 60 x 60 (G 76) 23,6" x 23,6" **m²** 6  
x 12 mm.



LANDS DESERT 60 x 60 (G 79) 23,6" x 23,6" **m²** 18  
x 12 mm.



LANDS JASPER 60 x 60 (G 79) 23,6" x 23,6" **m²** 18  
x 12 mm.



LANDS ANDES 60 x 60 (G 76) 23,6" x 23,6" **m²** 6  
x 12 mm.

# COTTAGE

EXTRUSIONADO PORCELÁNICO  
EXTRUDED PORCELAIN TILE

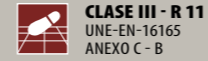

Pav. / Floor: Cottage Sun Antislip 60x60 - Peldaño Curvo Cottage Sun Antislip 60x33/4 - Ángulo Peldaño Curvo Cottage Sun Antislip 33x46/4  
Rev. / Wall: Cross Cottage Sun 15,5x15,5 - Taco Cottage Lacock 4x4



Pav. / Floor: Cottage Dune Antislip 60x60  
Peldaño Curvo Cottage Dune Antislip 60x33/4



Pav. / Floor: Cottage Mud 60x60  
Rev. / Wall: Star Cottage Mud 15,5x15,5 - Cross Cottage Mud 15,5x15,5 - Austral Beige 40x60



COTTAGE SUN  
COTTAGE SUN ANTISLIP  
\* STAR & CROSS 15,5 x 15,5 - 6" x 6" - CLASE II - R10



COTTAGE DUNE  
COTTAGE DUNE ANTISLIP  
\* STAR & CROSS 15,5 x 15,5 - 6" x 6" - CLASE II - R10



COTTAGE MUD  
COTTAGE MUD ANTISLIP  
\* STAR & CROSS 15,5 x 15,5 - 6" x 6" - CLASE II - R10



COTTAGE VOLCANO  
COTTAGE VOLCANO ANTISLIP  
\* STAR & CROSS 15,5 x 15,5 - 6" x 6" - CLASE II - R10

PIEZAS ESPECIALES  
SPECIAL PIECES

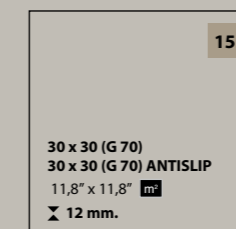
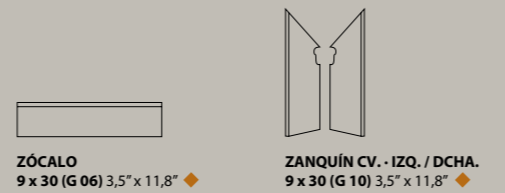
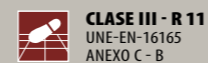

# COTTAGE

EXTRUSIONADO PORCELÁNICO  
EXTRUDED PORCELAIN TILE

CLASE I - R 9  
UNE-EN-16165  
ANEXO C - B



Pav. / Floor: Cottage Mud 60x60 - Cottage Mud 30x30



COTTAGE BOURTON 60 x 60 (G 76) 23,6" x 23,6"  $m^2$  4  
X 12 mm.



COTTAGE YORK 60 x 60 (G 76) 23,6" x 23,6"  $m^2$  4  
X 12 mm.



COTTAGE CASTLE 60 x 60 (G 76) 23,6" x 23,6"  $m^2$  4  
X 12 mm.



COTTAGE LACOCK 60 x 60 (G 76) 23,6" x 23,6"  $m^2$  4  
X 12 mm.

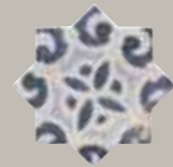

4

STAR COTTAGE BOURTON  
15,5 x 15,5 (G 84) 6" x 6"  $m^2$



TACO COTTAGE BOURTON  
4 x 4 (G 01) 1,5" x 1,5"  $m^2$



4

STAR COTTAGE CASTLE  
15,5 x 15,5 (G 84) 6" x 6"  $m^2$



TACO COTTAGE CASTLE  
4 x 4 (G 01) 1,5" x 1,5"  $m^2$



4

STAR COTTAGE YORK  
15,5 x 15,5 (G 84) 6" x 6"  $m^2$



TACO COTTAGE YORK  
4 x 4 (G 01) 1,5" x 1,5"  $m^2$



4

STAR COTTAGE LACOCK  
15,5 x 15,5 (G 84) 6" x 6"  $m^2$



TACO COTTAGE LACOCK  
4 x 4 (G 01) 1,5" x 1,5"  $m^2$



Pav. / Floor: Cottage Volcano 60x60 - Cottage Volcano 30x30



Pav. / Floor: Fuego Teja 45x45 · Fuego Teja 22,5x22,5 · Peldaño Curvo Fuego Teja 45x33/4



Pav. / Floor: Fuego Natural 45x45  
Rev. / Wall: Fuego Natural 45x45



Pav. / Floor: Fuego Antic 45x45 · Fuego Antic Brick 6,5x25 · Peldaño Curvo Fuego Antic 45x33/4 · Ángulo Peldaño Curvo Fuego Antic 33x46/4 · Zócalo Fuego Antic 9x45



FUEGO ANTIC  
FUEGO ANTIC ANTISLIP



FUEGO TEJA  
FUEGO ANTIC ANTISLIP



FUEGO NATURAL  
FUEGO ANTIC ANTISLIP



FUEGO BLANCO

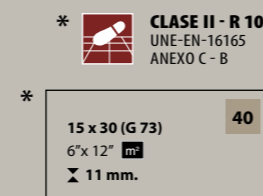
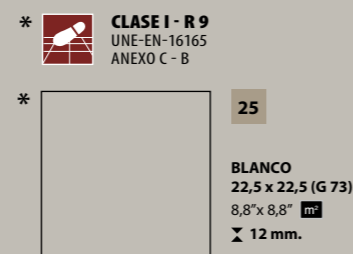
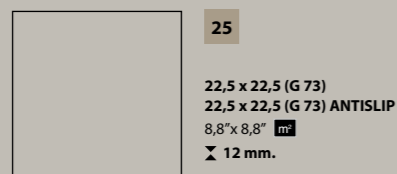
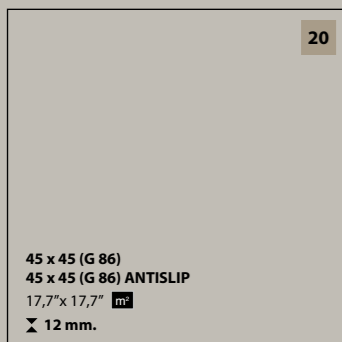

PIEZAS ESPECIALES · SPECIAL PIECES  
Disponible en NATURAL, ANTIC y TEJA · Available in NATURAL, ANTIC & TEJA



PELDAÑO CURVO  
PELDAÑO CURVO ANTISLIP  
45 x 33/4 (G 87) 17,7" x 13"/1,5" ◆



VIERTEAGUAS ANTISLIP  
15 x 22,5/4 (G 10) 5,9" x 8,8"/1,5" ◆



ÁNG. PELDAÑO CURVO  
ÁNG. PELDAÑO CURVO ANTISLIP  
33 x 46/4 (G 23 x 2PZ) 13" x 18"/1,5" ◆

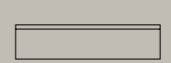

ZÓCALO  
9 x 45 (G 10) 3,5" x 17,7" ◆

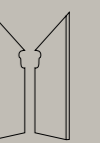

ZANQUÍN CV. · IZQ. / DCHA.  
9 x 45 (G 12) 3,5" x 17,7" ◆

# FUEGO

EXTRUSIONADO PORCELÁNICO  
EXTRUDED PORCELAIN TILE

CLASE II - R 10  
UNE-EN-16165  
ANEXO C - B



Rev. / Wall: Fuego Blanco 22,5x22,5 - Fuego Natural Brick 6,5x25 - Fuego Natural 45x45  
Pav. / Floor: Fuego Era 22,5x22,5 - Peldaño Curvo Fuego Natural 45x33/4 - Ángulo Peldaño Curvo Fuego Natural 33x46/4



FUEGO BLANCO



FUEGO NATURAL



FUEGO ANTIC



FUEGO TEJA



FUEGO MIX



33

BRICK  
6,5 x 25 (G 39) 2,5" x 10" **m²**  
± 11 mm.



Pav. / Floor: Fuego Natural Antislip 45x45 - Peldaño Curvo Fuego Natural Antislip 45x33/4

# FUEGO

EXTRUSIONADO PORCELÁNICO  
EXTRUDED PORCELAIN TILE

CLASE II - R 10  
UNE-EN-16165  
ANEXO C - B

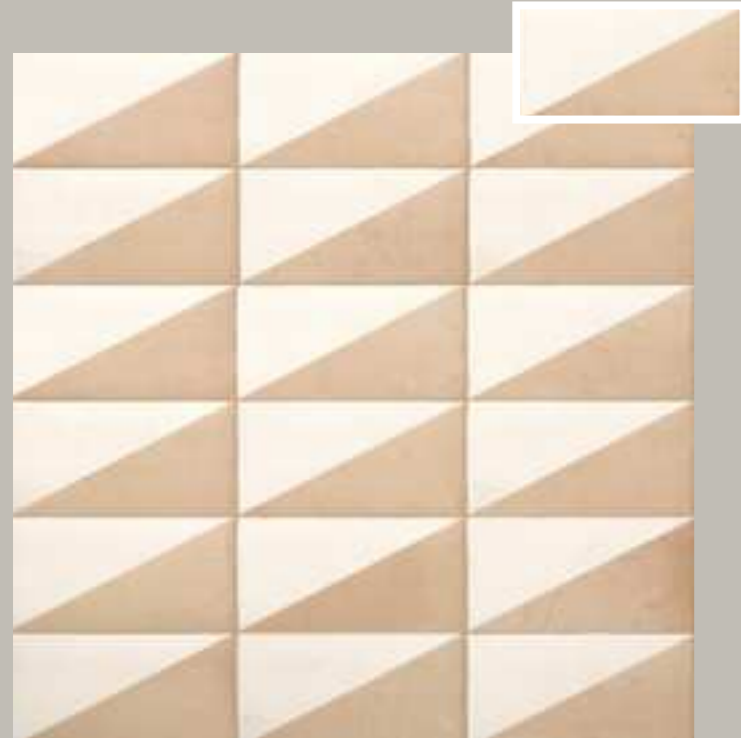

FUEGO LINAJE 15 x 30 (G 73) - 6" x 12" **m²**  
x 11 mm.

16

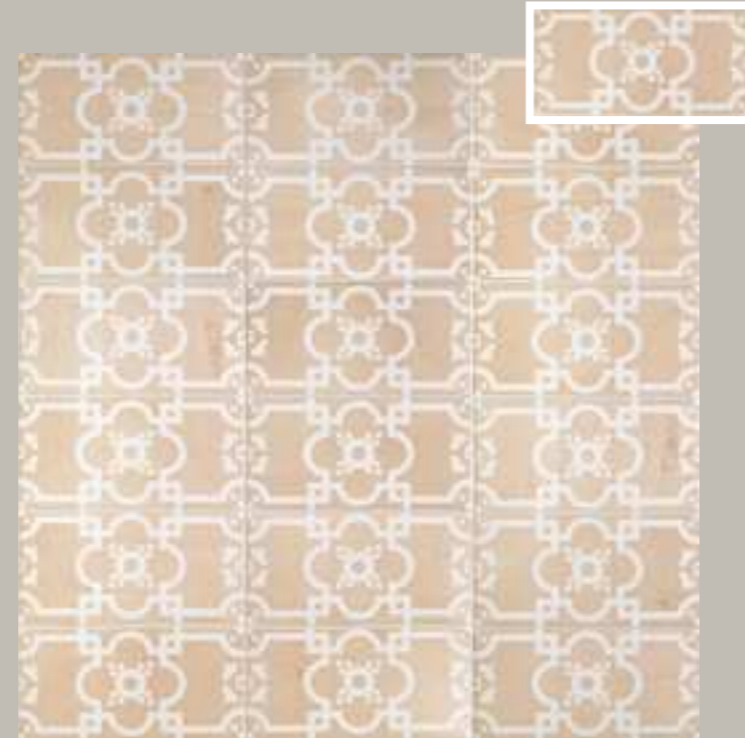

FUEGO HERENCIA 15 x 30 (G 73) - 6" x 12" **m²**  
x 11 mm.

16

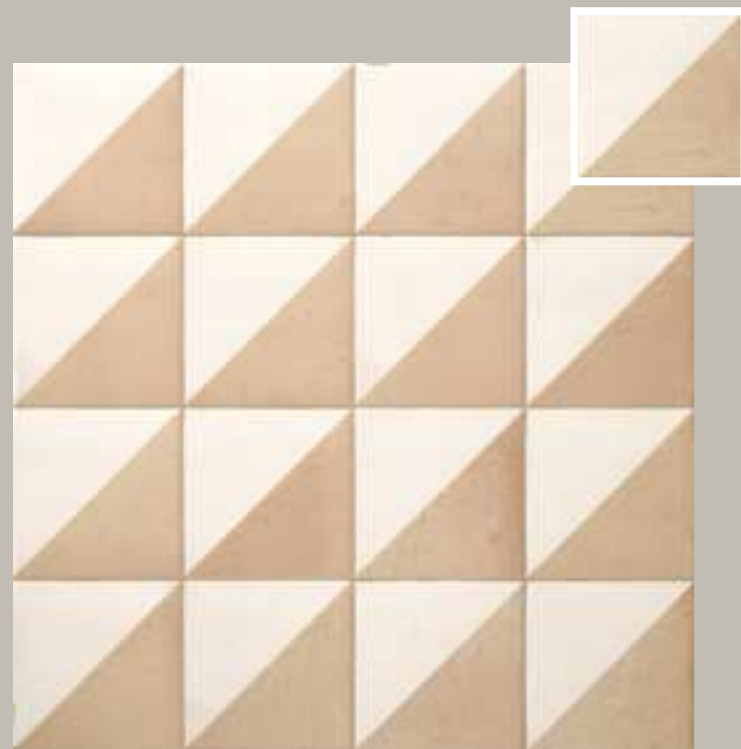

FUEGO LINAJE 22,5 x 22,5 (G 86) - 8,8" x 8,8" **m²**  
x 12 mm.

16



FUEGO ERA 22,5 x 22,5 (G 86) - 8,8" x 8,8" **m²**  
x 12 mm.

16



Rev. / Wall: Fuego Era 22,5x22,5 · Fuego Natural 15x30 · Fuego Natural Brick 6,5x25  
Pav. / Floor: Fuego Natural 45x45 · Fuego Natural 22,5x22,5



Rev. / Wall: Fuego Raices 22,5x22,5 · Fuego Antic 15x30 · Peldaño Curvo Fuego Antic 45x33/4



Pav. / Floor: Fuego Huella 22,5x22,5 · Zócalo Fuego Natural 9x45



FUEGO HUELLA 22,5 x 22,5 (G 86) · 8,8" x 8,8" **m**  
Σ 12 mm.

16



FUEGO RAICES 22,5 x 22,5 (G 86) · 8,8" x 8,8" **m**  
Σ 12 mm.

16

# FUEGO

EXTRUSIONADO PORCELÁNICO  
EXTRUDED PORCELAIN TILE

CLASE II - R 10  
UNE-EN-16165  
ANEXO C - B

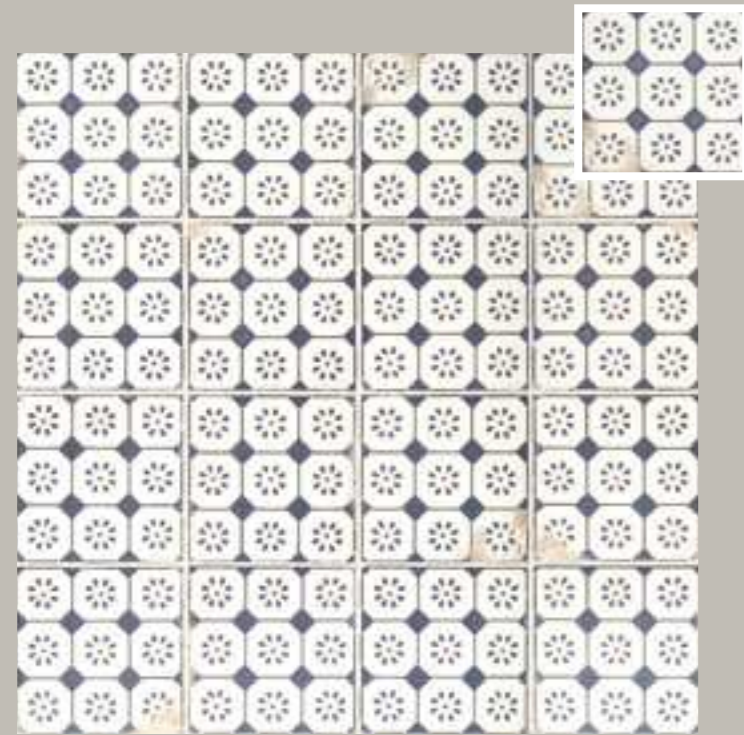

FUEGO TESSELAR 22,5 x 22,5 (G 86) · 8,8" x 8,8"  m<sup>2</sup>  
Σ 12 mm.

16



FUEGO ÉPOCA MIX 22,5 x 22,5 (G 86) · 8,8" x 8,8"  m<sup>2</sup>  
Σ 12 mm.  
(MIX DE: FUEGO TESSELAR, FUEGO RAICES, FUEGO LEGADO,  
FUEGO ESPLENDOR Y FUEGO HUELLA)

16



FUEGO ESPLENDOR 22,5 x 22,5 (G 86) · 8,8" x 8,8"  m<sup>2</sup>  
Σ 12 mm.

16



FUEGO LEGADO 22,5 x 22,5 (G 86) · 8,8" x 8,8"  m<sup>2</sup>  
Σ 12 mm.

16



Rev. / Wall: Fuego Tesselar 22,5x22,5 · Fuego Blanco 22,5x22,5  
Pav. / Floor: Fuego Natural 15x30

# ARGILE

EXTRUSIONADO PORCELÁNICO  
EXTRUDED PORCELAIN TILE

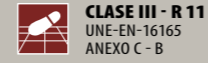

Pav. / Floor: Argile Ferrara 45x45 - Arrow Argile Bianco 7,4x48  
Rev. / Wall: Argile Bianco 15x15



Pav. / Floor: Argile Ferrara 45x45 - Square Argile Bianco 15x15



Pav. / Floor: Argile Palermo Antislip 45x45 - Argile Palermo Antislip 22,5x45  
Argile Palermo Antislip 22,5x22,5 - Peldaño Curvo Argile Palermo Antislip 45x33/4

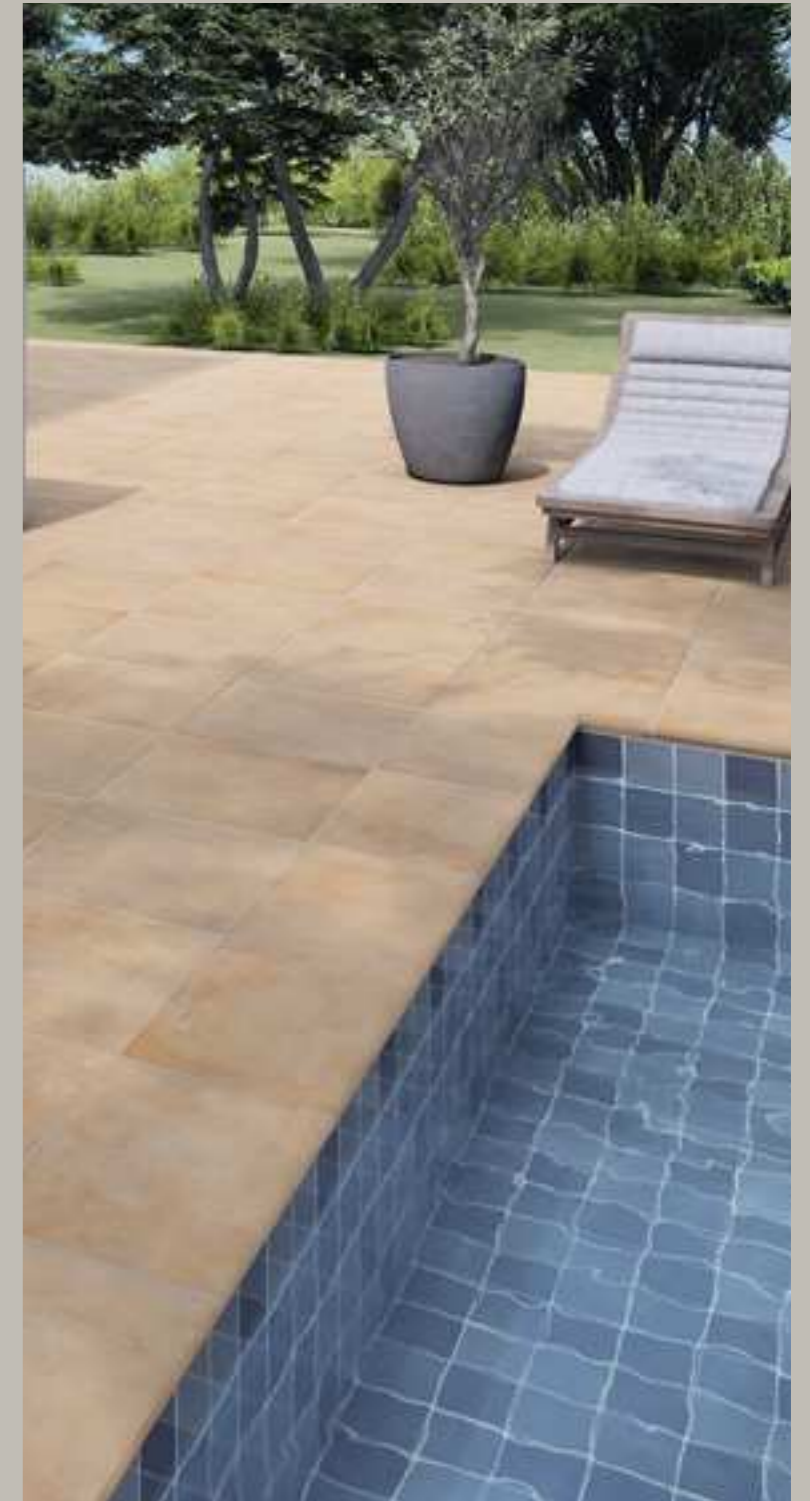

Pav. / Floor: Argile Verona Antislip 45x45 - Peldaño Curvo Argile Verona Antislip 45x33/4  
Vaso Piscina / Pool Basin: Pool Porc. Indigo Antislip Enm. 30,5x30,5



ARGILE FERRARA  
ARGILE FERRARA ANTISLIP



ARGILE VERONA  
ARGILE VERONA ANTISLIP



ARGILE PALERMO  
ARGILE PALERMO ANTISLIP

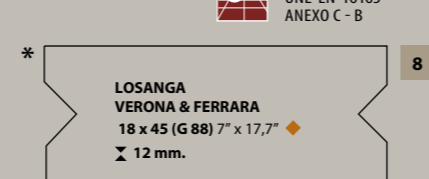
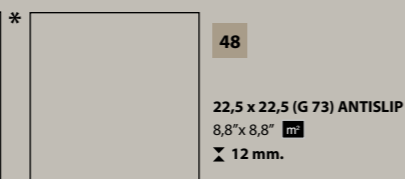
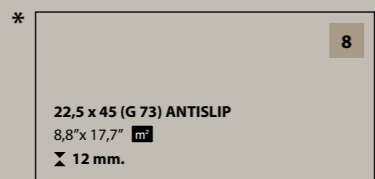
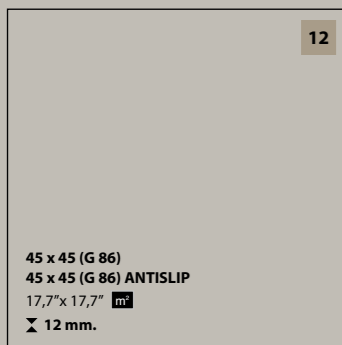

## PIEZAS ESPECIALES - SPECIAL PIECES



PELDAÑO CURVO ANTISLIP  
45 x 33/4 (G 87) 17,7" x 13"/1,5"

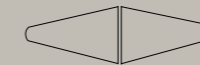

ÁNG. PELDAÑO CURVO ANTISLIP  
33 x 46/4 (G 23 x 2PZ) 13" x 18"/1,5"



ZÓCALO  
9 x 45 (G 10) 3,5" x 17,7"

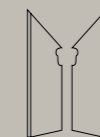

ZANQUÍN CV. - IZQ. / DCHA.  
9 x 45 (G 12) 3,5" x 17,7"



MÓDULO ANTISLIP (G 76)  $m^2$   
packing: 1,063  $m^2$ /caja

Cada caja contiene:  
3 piezas de 45x45  
3 piezas de 22,5x45  
3 piezas de 22,5x22,5

Each box contains:  
3 pieces 17,7"x17,7"  
3 pieces 8,8"x17,7"  
3 pieces 8,8"x8,8"

# ARGILE

EXTRUSIONADO PORCELÁNICO  
EXTRUDED PORCELAIN TILE

SPECIAL ORDER  
BAJO PEDIDO

CLASE I - R 9  
UNE-EN-16165  
ANEXO C - B



MATE  
MATT

BRILLO  
GLOSS



Rev. / Wall: **Arrow Argile Verde 7,4x48**



Pav. / Floor: **Argile Ferrara Antislip 45x45 · Losagna Argile Ferrara 18x45  
Star Argile Aquamarina 18x18 · Taco Argile Aquamarina 4x4**



Pav. / Floor: **Argile Verona Antislip 22,5x45 · Taco Argile Blu 15x15**



Pav. y Rev. / Floor & Wall: **Arrow Argile Cotto 7,4x48 · Arrow Argile Bianco 7,4x48**



**SQUARE ARGILE VERDE 15 x 15 (G 72) 6" x 6" m<sup>2</sup>**  
**TACO ARGILE VERDE 15 x 15 (G 07) 6" x 6" ◆**  
⊗ 10 mm.



**SQUARE ARGILE AQUAMARINA 15 x 15 (G 72) 6" x 6" m<sup>2</sup>**  
**TACO ARGILE AQUAMARINA 15 x 15 (G 07) 6" x 6" ◆**  
⊗ 10 mm.



**SQUARE ARGILE BLU 15 x 15 (G 72) 6" x 6" m<sup>2</sup>**  
**TACO ARGILE BLU 15 x 15 (G 07) 6" x 6" ◆**  
⊗ 10 mm.



**SQUARE ARGILE BIANCO 15 x 15 (G 72) 6" x 6" m<sup>2</sup>**  
**TACO ARGILE BIANCO 15 x 15 (G 07) 6" x 6" ◆**  
⊗ 10 mm.



**CROSS COTTO 18 x 18 (G 84) 7" x 7" m<sup>2</sup>**  
**CRUZ COTTO 18 x 18 (G 75) 7" x 7" ◆**  
⊗ 10 mm.



PIEZAS ESPECIALES · SPECIAL PIECES  
Disponibile en PALERMO, VERONA y FERRARA  
Available in all colors PALERMO, VERONA & FERRARA



**ARROW ARGILE VERDE 7,4 x 48 (G 83) 3" x 19" m<sup>2</sup>**  
**LANZA ARGILE VERDE 7,4 x 48 (G 09) 3" x 19" ◆**  
⊗ 10 mm.



**ARROW ARGILE BLU 7,4 x 48 (G 83) 3" x 19" m<sup>2</sup>**  
**LANZA ARGILE BLU 7,4 x 48 (G 09) 3" x 19" ◆**  
⊗ 10 mm.



**ARROW ARGILE BIANCO 7,4 x 48 (G 83) 3" x 19" m<sup>2</sup>**  
**LANZA ARGILE BIANCO 7,4 x 48 (G 09) 3" x 19" ◆**  
⊗ 10 mm.



**ARROW COTTO 7,4 x 48 (G 83) 3" x 19" m<sup>2</sup>**  
**LANZA COTTO 7,4 x 48 (G 09) 3" x 19" ◆**  
⊗ 10 mm.

DEMI-BULLNOSE  
1,5 x 30 (G 07) 0,6" x 11,8" ◆



**TACO ARGILE VERDE 4 x 4 (G 01) 2" x 2" ◆**  
⊗ 10 mm.



**TACO ARGILE AQUAMARINA 4 x 4 (G 01) 2" x 2" ◆**  
⊗ 10 mm.



**TACO ARGILE BLU 4 x 4 (G 01) 2" x 2" ◆**  
⊗ 10 mm.



**TACO ARGILE BIANCO 4 x 4 (G 01) 2" x 2" ◆**  
⊗ 10 mm.



**STAR ARGILE VERDE 18 x 18 (G 84) 7" x 7" m<sup>2</sup>**  
**ESTRELLA ARGILE VERDE 18 x 18 (G 75) 7" x 7" ◆**  
⊗ 10 mm.



**STAR ARGILE AQUAMARINA 18 x 18 (G 84) 7" x 7" m<sup>2</sup>**  
**ESTRELLA ARGILE AQUAMARINA 18 x 18 (G 75) 7" x 7" ◆**  
⊗ 10 mm.

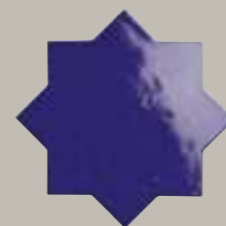

**STAR ARGILE BLU 18 x 18 (G 84) 7" x 7" m<sup>2</sup>**  
**ESTRELLA ARGILE BLU 18 x 18 (G 75) 7" x 7" ◆**  
⊗ 10 mm.



**STAR ARGILE BIANCO 18 x 18 (G 84) 7" x 7" m<sup>2</sup>**  
**ESTRELLA ARGILE BIANCO 18 x 18 (G 75) 7" x 7" ◆**  
⊗ 10 mm.



**CROSS ARGILE BIANCO 18 x 18 (G 84) 7" x 7" m<sup>2</sup>**  
**CRUZ ARGILE BIANCO 18 x 18 (G 75) 7" x 7" ◆**  
⊗ 10 mm.



**CROSS FORESTA 18 x 18 (G 84) 7" x 7" m<sup>2</sup>**  
**CRUZ FORESTA 18 x 18 (G 75) 7" x 7" ◆**  
⊗ 10 mm.



**ARROW FORESTA 7,4 x 48 (G 83) 3" x 19" m<sup>2</sup>**  
**LANZA FORESTA 7,4 x 48 (G 09) 3" x 19" ◆**  
⊗ 10 mm.

# ARGILE

EXTRUSIONADO PORCELÁNICO  
EXTRUDED PORCELAIN TILE

CLASE I - R 9  
UNE-EN-16165  
ANEXO C - B



Rev. / Wall: **Square Fiorano 15x15**



Pav. / Floor: **Argile Verona 45x45 - Losagna Argile Verona 18x45 - Star Venice 18x18**



Pav. / Floor: **Argile Modena 22,5x22,5**

SATINADO  
SATIN



**SQUARE FIORANO 15 x 15 (G 72) 6" x 6" m<sup>2</sup>**  
X 10 mm.



**STAR VENICE A 18 x 18 (G 84) 7" x 7" m<sup>2</sup>**  
X 10 mm.



**STAR VENICE B 18 x 18 (G 84) 7" x 7" m<sup>2</sup>**  
X 10 mm.



**STAR VENICE C 18 x 18 (G 84) 7" x 7" m<sup>2</sup>**  
X 10 mm.



**FRONT FIORANO 15 x 45 (G 72) 6" x 17,7" m<sup>2</sup>**  
X 10 mm.



**FRONT VENICE 15 x 45 (G 72) 6" x 17,7" m<sup>2</sup>**  
X 10 mm.



**SQUARE VENICE 15 x 15 (G 72) 6" x 6" m<sup>2</sup>**  
X 10 mm.



**TACO VENICE 4 x 4 (G 04) 2" x 2" ♦**  
X 10 mm.



**TACO VENICE 5 x 5 (G 04) 2" x 2" ♦**  
X 10 mm.

MATE  
MATT



**ARGILE UDINE 22,5 x 22,5 (G 73) 8,8" x 8,8" m<sup>2</sup>**  
X 10 mm.

12



**ARGILE RAVENNA 22,5 x 22,5 (G 73) 8,8" x 8,8" m<sup>2</sup>**  
X 10 mm.

12



**ARGILE MODENA 22,5 x 22,5 (G 73) 8,8" x 8,8" m<sup>2</sup>**  
X 10 mm.

12

\*  CLASE II - R 10  
UNE-EN-16165  
ANEXO C - B

# COTTO BRICK

EXTRUSIONADO PORCELÁNICO  
EXTRUDED PORCELAIN TILE

CLASE II - R 10  
UNE-EN-16165  
ANEXO C - B



Pav. / Floor: Cotto Brick Clay 7x60



COTTO BRICK CLEAR 7 x 60 (G 77) 3" x 24"  $m^2$  6  
x 10 mm.



COTTO BRICK SAND 7 x 60 (G 77) 3" x 24"  $m^2$  6  
x 10 mm.

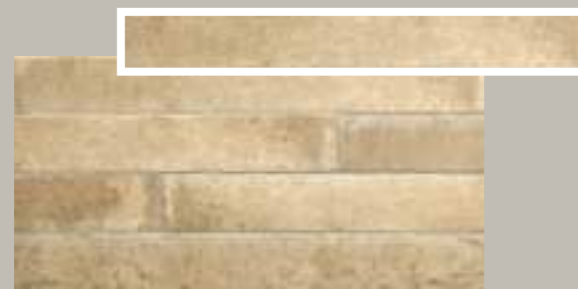

COTTO BRICK LINEN 7 x 60 (G 77) 3" x 24"  $m^2$  6  
x 10 mm.



COTTO BRICK CLAY 7 x 60 (G 77) 3" x 24"  $m^2$  6  
x 10 mm.

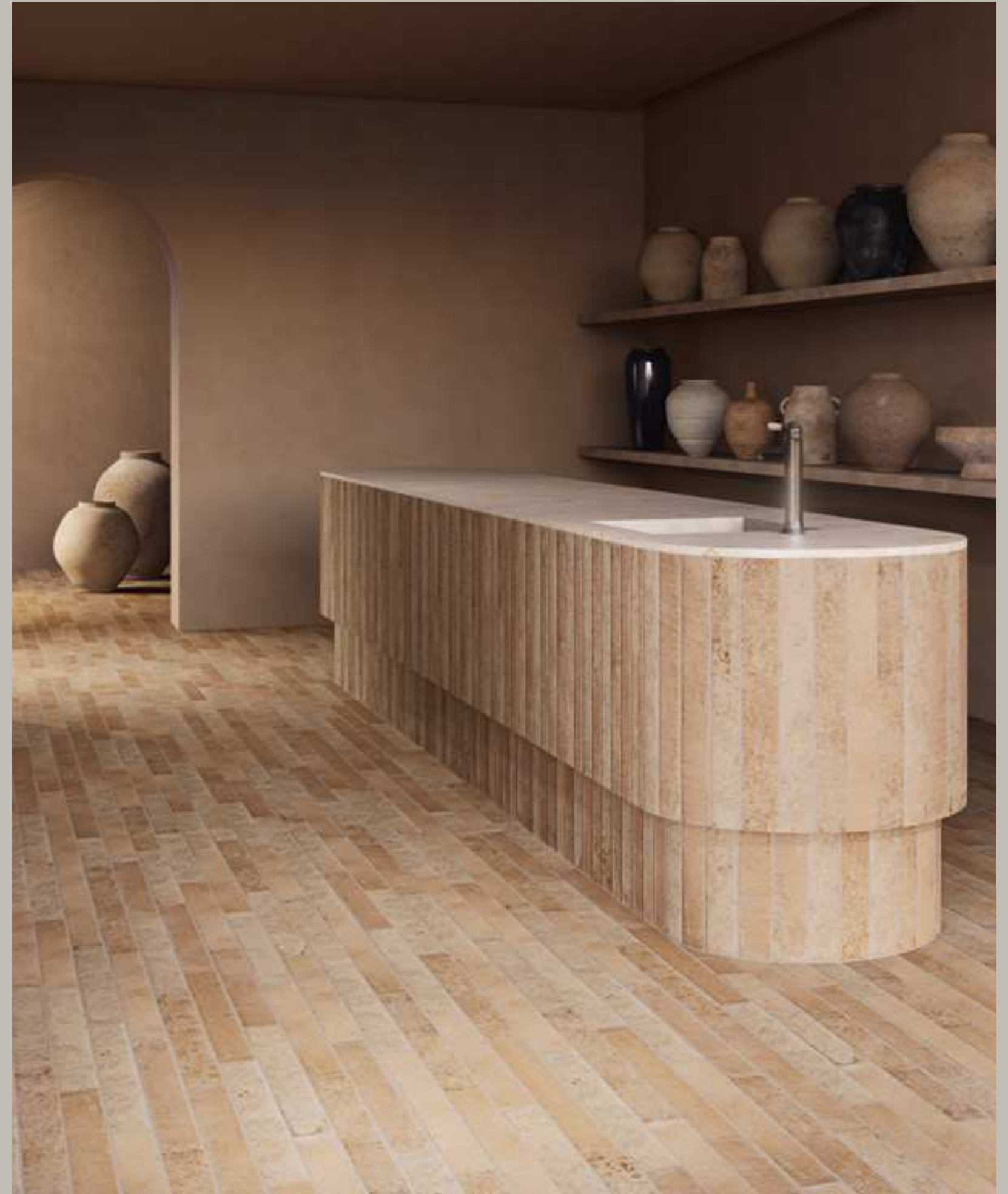

Pav. / Floor: Cotto Brick Sand 7x60  
Rev. / Wall: Cotto Brick Sand 7x60



Rev. / Wall: **Unika Artico 11x22,5** - **Cross Unika Artico 15,5x15,5** - **Taco Unika Barro 4x4**  
Pav. / Floor: **Unika Barro 22,5x45**



Rev. / Wall: **Unika Sage 22,5x45** - **Cross Unika Sage 15,5x15,5** - **Star Unika Sage 15,5x15,5**  
Pav. / Floor: **Unika Sage 22,5x45** - **Peldaño Recto Unika Sage 45x32/3** - **Sherwood Birch 20x120**

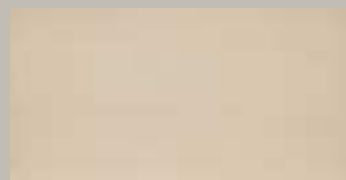

UNIKA TOPO

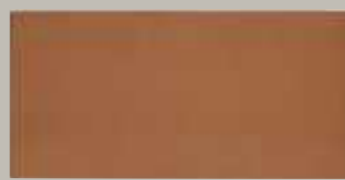

UNIKA BARRO



UNIKA SAGE

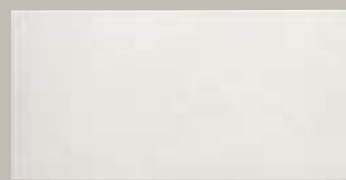

UNIKA ARTICO



UNIKA DENIM

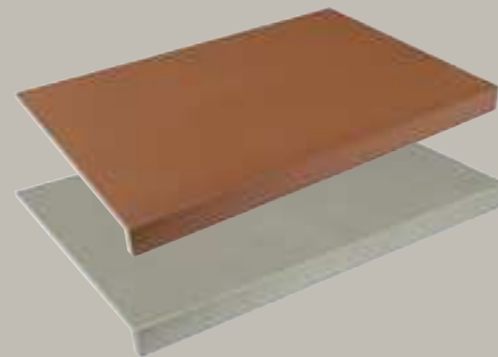

PIEZAS ESPECIALES · SPECIAL PIECES  
Disponible en BARRO y SAGE · Available in BARRO & SAGE



**PELDAÑO RECTO**  
45 x 32/3 (G 87) 17,7" x 12,5"/1"

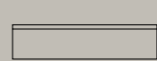

**ZÓCALO**  
9 x 45 (G 10) 3,5" x 17,7"

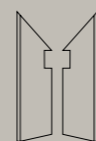

**ZANQUÍN RECTO.**  
IZQ. / DCHA.  
9 x 45 (G 12) 3,5" x 17,7"

**7**

22,5 x 45 (G 68)  
8,8" x 17,7" **m²**  
± 10 mm.

**28**

22,5 x 22,5 (G 68)  
8,8" x 8,8" **m²**  
± 10 mm.

**28**

11 x 22,5 (G 86)  
4,3" x 8,8" **m²**  
± 10 mm.



Rev. / Wall: **Unika Topo 11x22,5**  
Pav. / Floor: **Cross Unika Topo 15,5x15,5** - **Taco Unika Artico 4x4**



Pav. / Floor: Taco Unika Denim 4x4 - Cross Unika Artico 15,5x15,5  
Rev. / Wall: Unika Denim 11x22,5



Pav. / Floor: Cross Unika Sage 15,5x15,5 - Star Unika Sage 15,5x15,5



Rev. / Wall: Cross Unika Barro 15,5x15,5 - Star Unika Barro 15,5x15,5  
Pav. / Floor: Unika Barro 22,5x45



Pav. / Floor: Cross Unika Topo 15,5x15,5 - Star Unika Topo 15,5x15,5 - Unika Topo 22,5x22,5  
Rev. / Wall: Unika Topo 22,5x22,5



**TACO CUADRI UNIKA TOPO**  
4 x 4 (G 01) 1,5" x 1,5" ♦  
X 10 mm.



**TACO ROMBI UNIKA TOPO**  
4 x 4 (G 01) 1,5" x 1,5" ♦  
X 10 mm.



**TACO UNIKA DENIM**  
4 x 4 (G 01) 1,5" x 1,5" ♦  
X 10 mm.



**TACO UNIKA SAGE**  
4 x 4 (G 01) 1,5" x 1,5" ♦  
X 10 mm.



**TACO UNIKA BARRO**  
4 x 4 (G 01) 1,5" x 1,5" ♦  
X 10 mm.



**TACO UNIK TOPO**  
4 x 4 (G 01) 1,5" x 1,5" ♦  
X 10 mm.



**TACO UNIK ARTICO**  
4 x 4 (G 01) 1,5" x 1,5" ♦  
X 10 mm.



**TACO CUADRI UNIKA BARRO**  
4 x 4 (G 01) 1,5" x 1,5" ♦  
X 10 mm.



**TACO ROMBI UNIKA BARRO**  
4 x 4 (G 01) 1,5" x 1,5" ♦  
X 10 mm.



**CROSS UNIKA DENIM**  
15,5 x 15,5 (G 81) 6" x 6" m<sup>2</sup>  
X 10 mm.



**CROSS UNIKA SAGE**  
15,5 x 15,5 (G 81) 6" x 6" m<sup>2</sup>  
X 10 mm.



**CROSS UNIKA BARRO**  
15,5 x 15,5 (G 81) 6" x 6" m<sup>2</sup>  
X 10 mm.



**CROSS UNIKA TOPO**  
15,5 x 15,5 (G 81) 6" x 6" m<sup>2</sup>  
X 10 mm.



**CROSS UNIKA ARTICO**  
15,5 x 15,5 (G 81) 6" x 6" m<sup>2</sup>  
X 10 mm.



**TACO CUADRI UNIKA SAGE**  
4 x 4 (G 01) 1,5" x 1,5" ♦  
X 10 mm.



**TACO ROMBI UNIKA SAGE**  
4 x 4 (G 01) 1,5" x 1,5" ♦  
X 10 mm.



**STAR UNIKA DENIM**  
15,5 x 15,5 (G 81) 6" x 6" m<sup>2</sup>  
X 10 mm.



**STAR UNIKA SAGE**  
15,5 x 15,5 (G 81) 6" x 6" m<sup>2</sup>  
X 10 mm.



**STAR UNIKA BARRO**  
15,5 x 15,5 (G 81) 6" x 6" m<sup>2</sup>  
X 10 mm.



**STAR UNIKA TOPO**  
15,5 x 15,5 (G 81) 6" x 6" m<sup>2</sup>  
X 10 mm.



**STAR UNIKA ARTICO**  
15,5 x 15,5 (G 81) 6" x 6" m<sup>2</sup>  
X 10 mm.



**TACO CUADRI UNIKA DENIM**  
4 x 4 (G 01) 1,5" x 1,5" ♦  
X 10 mm.



**TACO ROMBI UNIKA DENIM**  
4 x 4 (G 01) 1,5" x 1,5" ♦  
X 10 mm.

IDEAS DE COLOCACIÓN - LAYOUT IDEAS

Escala reducida - Reduced scale

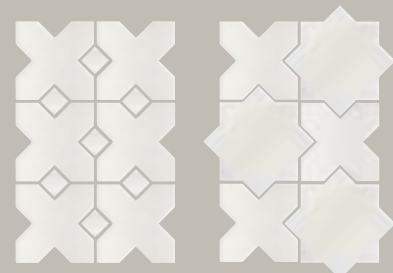
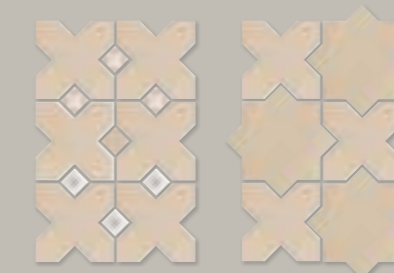
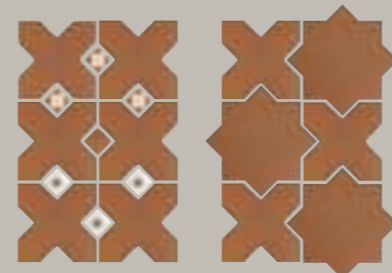
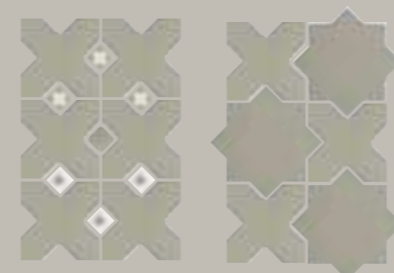
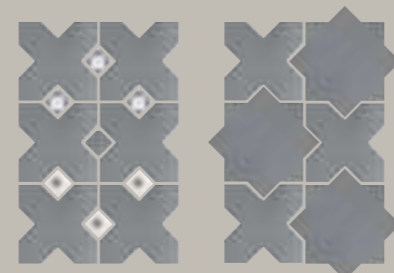



Pav. / Floor: **Unika Topo 22,5x45** - **Unika Boho 22,5x22,5**  
Rev. / Wall: **Unika Topo 11x22,5**



Pav. / Floor: **Unika Trival 22,5x22,5**  
Rev. / Wall: **Unika Sage 22,5x22,5** - **Unika Artico 11x22,5**



Rev. / Wall: **Unika Topo 11x22,5** - **Unika Denim 11x22,5**  
Pav. / Floor: **Unika Revival 22,5x22,5**



Pav. / Floor: **Unika Midcentury 22,5x22,5**



IDEAS DE COLOCACIÓN  
LAYOUT IDEAS

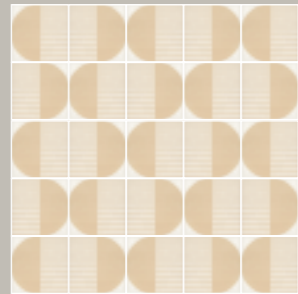

**UNIKA BOHO 22,5 x 22,5 (G 86) 8,8" x 8,8" m²**  
⊗ 10 mm.



**UNIKA TRIVAL 22,5 x 22,5 (G 86) 8,8" x 8,8" m²**  
⊗ 10 mm.



**UNIKA REVIVAL 22,5 x 22,5 (G 86) 8,8" x 8,8" m²**  
⊗ 10 mm.

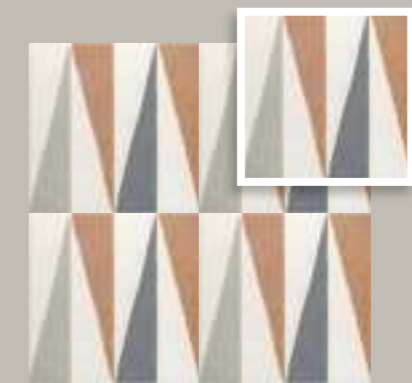

IDEAS DE COLOCACIÓN  
LAYOUT IDEAS



**UNIKA MIDCENTURY 22,5 x 22,5 (G 86) 8,8" x 8,8" m²**  
⊗ 10 mm.

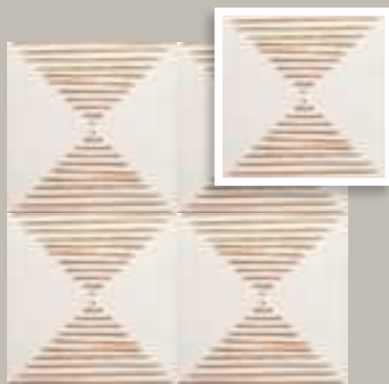

IDEAS DE COLOCACIÓN  
LAYOUT IDEAS



**UNIKA ZEN 22,5 x 22,5 (G 86) 8,8" x 8,8" m²**  
⊗ 10 mm.



**UNIKA URBANO 22,5 x 22,5 (G 86) 8,8" x 8,8" m²**  
⊗ 10 mm.

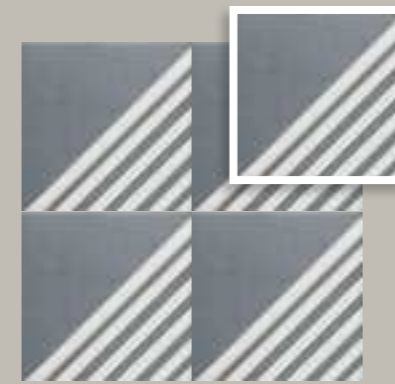

IDEAS DE COLOCACIÓN  
LAYOUT IDEAS

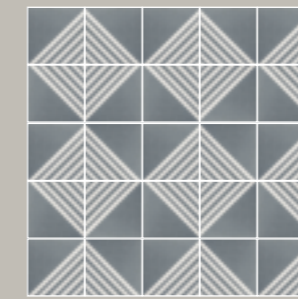

**UNIKA NEOLINE 22,5 x 22,5 (G 86) 8,8" x 8,8" m²**  
⊗ 10 mm.



IDEAS DE COLOCACIÓN  
LAYOUT IDEAS



**UNIKA SFERA 22,5 x 22,5 (G 86) 8,8" x 8,8" m²**  
⊗ 10 mm.

# D'ANTICATTO

EXTRUSIONADO PORCELÁNICO  
EXTRUDED PORCELAIN TILE

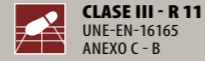

Pav. / Floor: D'Anticatto Muschio Antislip 22,5x22,5 - Peldaño Curvo D'Anticatto Muschio Antislip 22,5x33/4



Pav. / Floor: D'Anticatto Marrone Antislip 22,5x45 - D'Anticatto Marrone Antislip 11x22,5



Pav. / Floor: D'Anticatto Grigio Antislip 22,5x45 - D'Anticatto Grigio Antislip 22,5x22,5 - Peldaño Curvo D'Anticatto Grigio Antislip 22,5x33/4



D'ANTICATTO MUSCHIO ANTISLIP



D'ANTICATTO AZURRO ANTISLIP



D'ANTICATTO MARRONE ANTISLIP



D'ANTICATTO BIANCO ANTISLIP



D'ANTICATTO GRIGIO ANTISLIP



D'ANTICATTO NOTTE ANTISLIP

## ESPECIFICACIONES TÉCNICAS · TECHNICAL SPECIFICATIONS



RESISTE LA FLEXIÓN  
29 N/mm<sup>2</sup>



RESISTE EL DESGASTE  
PEI (II - IV)



RESISTE EL RAYADO  
MOHS - 9



MANCHAS  
Clase 5  
Clase A



ABSORCIÓN  
< 0,5%



DILATACIÓN  
6,0° 10° / °C

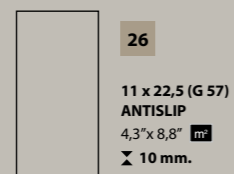
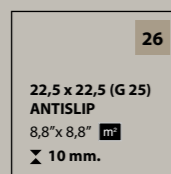
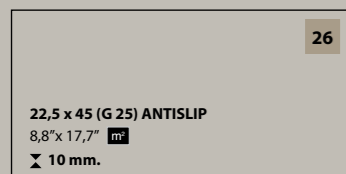

## PIEZAS ESPECIALES · SPECIAL PIECES



PELDAÑO CURVO ANTISLIP  
22,5 x 33/4 (G 16) 8,8" x 13"/1,5" ◆



ÁNG. PELDAÑO CURVO ANTISLIP  
33 x 46/4 (G 19 x 2PZ) 13" x 18"/1,5" ◆



ÁNG. PELD. CURVO 4PZ. ANTISLIP  
33 x 33/4 (G 58 x juego) 13" x 13"/1,5" ◆



ZÓCALO  
9 x 30 (G 06) 3,5" x 11,8" ◆

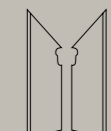

ZANQUÍN CV. · IZQ. / DRCH.  
9 x 30 (G 10) 3,5" x 11,8" ◆

# D'ANTICATTO

EXTRUSIONADO PORCELÁNICO  
EXTRUDED PORCELAIN TILE

CLASE III - R 11  
UNE-EN-16165  
ANEXO C - B

CLASS C  
UNE-EN-16165  
ANEXO A



Pav. / Floor: **Obliqua Antislip 22,5x22,5**



Pav. / Floor: **Triangoli Antislip 22,5x22,5**



**OBLIQUA ANTISLIP 22,5 x 22,5 (G 57) 8,8" x 8,8" m<sup>2</sup>**  
x 10 mm.

25

D'ANTICATTO OBLIQUA PERMITE  
MÚLTIPLES POSIBILIDADES  
COMPOSITIVAS

D'ANTICATTO OBLIQUA OFFERS  
INFINITE LAYOUTS  
POSSIBILITIES

D'ANTICATTO OBLIQUA PERMET  
DE MULTIPLES POSSIBILITÉS  
COMPOSITIVES

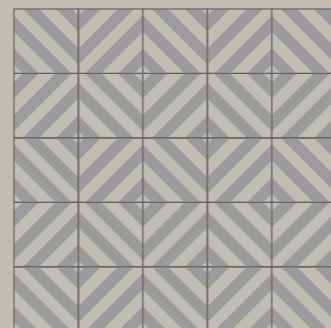
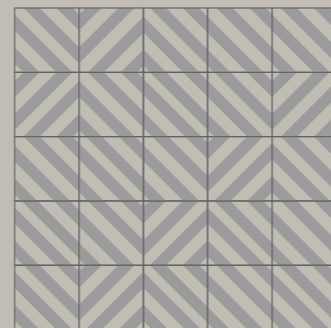
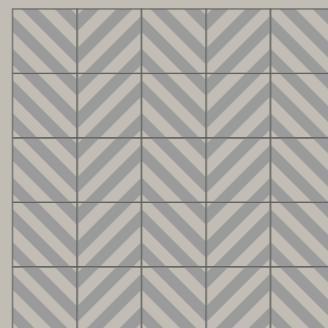

**TRIANGOLI ANTISLIP 22,5 x 22,5 (G 57) 8,8" x 8,8" m<sup>2</sup>**  
x 10 mm.

25



**QUADRATI ANTISLIP 22,5 x 22,5 (G 57) 8,8" x 8,8" m<sup>2</sup>**  
x 10 mm.

25

# D'ANTICATTO

EXTRUSIONADO PORCELÁNICO  
EXTRUDED PORCELAIN TILE

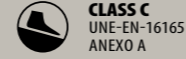
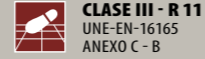

MIX VARESE ANTISLIP 22,5 x 22,5 (G 57) 8,8" x 8,8" **m²**  
 ✂ 10 mm.

25

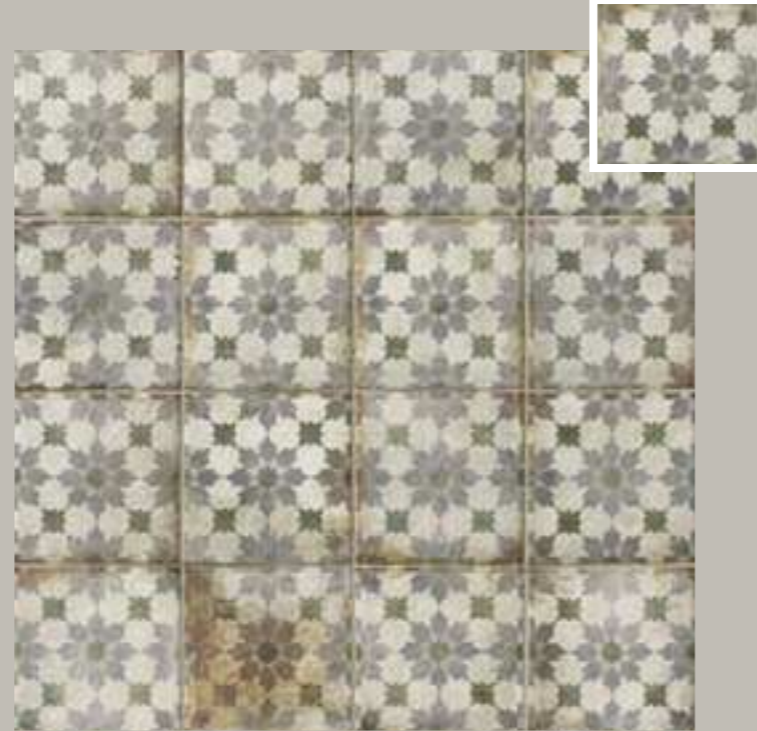

VARENNA ANTISLIP 22,5 x 22,5 (G 57) 8,8" x 8,8" **m²**  
 ✂ 10 mm.

25



FLORENCE ANTISLIP 22,5 x 22,5 (G 57) 8,8" x 8,8" **m²**  
 ✂ 10 mm.

25



LATERZA 2 ANTISLIP 2,5 x 22,5 (G 57) 8,8" x 8,8" **m²**  
 ✂ 10 mm.

25



Pav. / Floor: Mix Varese Antislip 22,5x22,5

# BOSTON

EXTRUSIONADO PORCELÁNICO  
EXTRUDED PORCELAIN TILE

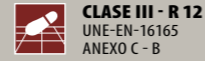

Rev. / Wall: Boston East Antislip 11x22,5



Rev. / Wall: Boston West Antislip 22,5x22,5 - Boston West Antislip 11x22,5



Pav. / Floor: Boston North Antislip 22,5x45



Pav. / Floor: Boston South Antislip 36x36 - Boston South Antislip 11x22,5  
Vierteaguas Boston South Antislip 15x22,5/4



BOSTON DOWNTOWN ANTISLIP



BOSTON EAST ANTISLIP



BOSTON NORTH ANTISLIP

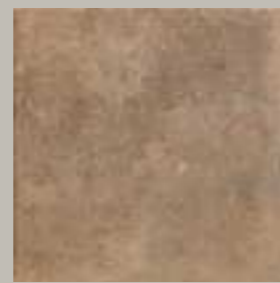

BOSTON SOUTH ANTISLIP



BOSTON WEST ANTISLIP

## ESPECIFICACIONES TÉCNICAS - TECHNICAL SPECIFICATIONS



RESISTE LA FLEXIÓN  
37 N/mn2



RESISTE EL DESGASTE  
PEI (III - IV)



RESISTE EL RAYADO  
MOHS - 9



MANCHAS  
Clase 5  
Clase A



ABSORCIÓN  
< 0,1%



DILATACIÓN  
6,4° 10° / °C



Solo disponible en DOWNTOWN, EAST y NORTH  
Only available in DOWNTOWN, EAST & NORTH

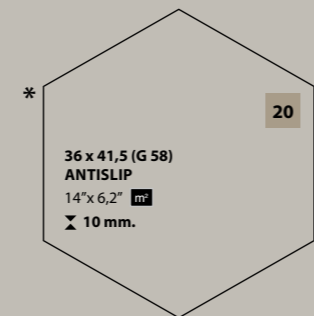
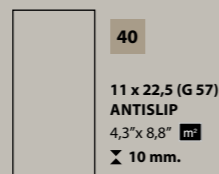
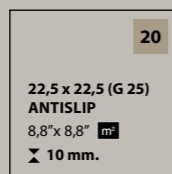
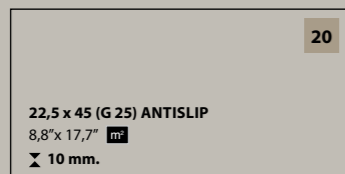
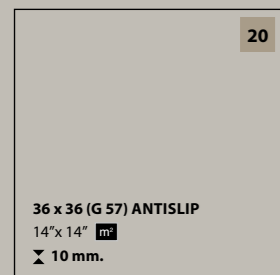

## PIEZAS ESPECIALES - SPECIAL PIECES



PELDAÑO CURVO ANTISLIP  
36 x 33/4 (G 18) 14" x 13"/1,5" ♦  
22,5 x 33/4 (G 16) 8,8" x 13"/1,5" ♦

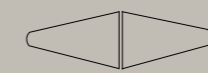

ÁNG. PELDAÑO CURVO ANTISLIP  
33 x 46/4 (G 19 x 2PZ) 13" x 18"/1,5" ♦

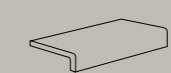

VIERTEAGUAS ANTISLIP  
15 x 22,5/4 (G 10) 5,9" x 8,8"/1,5" ♦

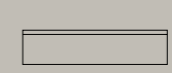

ZÓCALO  
9 x 36 (G 07) 3,5" x 14" ♦

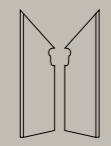

ZANQUÍN CV. - IZQ. / DRCH.  
9 x 36 (G 10) 3,5" x 14" ♦

# AMERICAN

EXTRUSIONADO PORCELÁNICO  
EXTRUDED PORCELAIN TILE

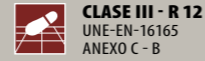

Pav. / Floor: American Melrose Antislip 22,5x22,5



Pav. / Floor: American Newton Antislip 22,5x22,5



AMERICAN MELROSE (MIX) ANTISLIP 22,5 x 22,5 (G 57) 8,8" x 8,8"  $m^2$   
x 10 mm.

20



AMERICAN NEWTON ANTISLIP 22,5 x 22,5 (G 57) 8,8" x 8,8"  $m^2$   
x 10 mm.

20



AMERICAN CLEVELAND ANTISLIP 22,5 x 22,5 (G 57) 8,8" x 8,8"  $m^2$   
x 10 mm.

20

# BOSTON BRICK

EXTRUSIONADO PORCELÁNICO  
EXTRUDED PORCELAIN TILE

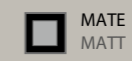
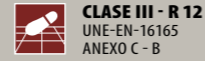

Pav. / Floor: Boston Brick East-North Antislip 6,5x25



Rev. / Wall: Boston Brick West Antislip 6,5x25



Rev. / Wall: Boston Brick Downtown Antislip 6,5x25  
Pav. / Floor: Cottage Volcano 60x60



BOSTON BRICK DAY  
\* 6,5 x 25 - 2,5"x 10" - CLASE I - R9



BOSTON BRICK EAST - NORTH ANTISLIP



BOSTON BRICK DOWNTOWN ANTISLIP



BOSTON BRICK NIGHT  
\* 6,5 x 25 - 2,5"x 10" - CLASE I - R9



BOSTON BRICK SOUTH ANTISLIP



BOSTON BRICK WEST ANTISLIP



BRICK ANTISLIP  
6,5 x 25 (G 39) 2,5"x 10"  $m^2$   
x 10 mm.



BRICK DAY & NIGHT  
6,5 x 25 (G 39) 2,5"x 10"  $m^2$   
x 10 mm.



# COTTO NATURE

EXTRUSIONADO PORCELÁNICO  
EXTRUDED PORCELAIN TILE

CLASE III - R 11  
UNE-EN-16165  
ANEXO C - B



Pav. / Floor: Cotto Nature Sicilia Antislip 30x30 - Vierteaguas Cotto Nature Sicilia Antislip 15x30/4



Pav. / Floor: Cotto Nature Siena Antislip 36x36 - Peldaño Curvo Cotto Nature Siena Antislip 36x33/4 - Vierteaguas Cotto Nature Siena Antislip 15x30/4 - Zócalo Cotto Nature Siena 9x30 - Zanquín CV. Cotto Nature Siena 9x30



COTTO NATURE SICILIA ANTISLIP



COTTO NATURE SIENA ANTISLIP



COTTO NATURE CERDEÑA ANTISLIP

## ESPECIFICACIONES TÉCNICAS - TECHNICAL SPECIFICATIONS



RESISTE LA FLEXIÓN  
29 N/mm<sup>2</sup>



RESISTE EL DESGASTE  
PEI (III - IV)



RESISTE EL RAYADO  
MOHS - 8



MANCHAS  
Clase 5  
Clase A



ABSORCIÓN  
0,2%



DILATACIÓN  
5,7\* 10<sup>-4</sup> / °C

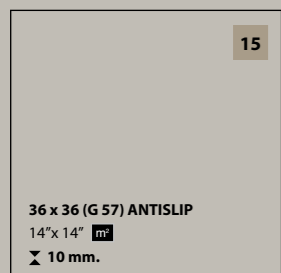

## PIEZAS ESPECIALES - SPECIAL PIECES



PELDAÑO CURVO ANTISLIP  
30 x 33/4 (G 17) 11,8" x 13"/1,5"  
36 x 33/4 (G 18) 14" x 13"/1,5"



ÁNG. PELDAÑO CURVO ANTISLIP  
33 x 46/4 (G 19 x 2PZ) 13" x 18"/1,5"



VIERTEAGUAS ANTISLIP  
15 x 30/4 (G 12) 5,9" x 11,8"/1,5"

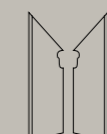

ZANQUÍN CV. - IZQ. / DCHA.  
9 x 30 (G 10) 3,5" x 11,8"



ZÓCALO  
9 x 30 (G 06) 3,5" x 11,8"

# COTTO NATURE

EXTRUSIONADO PORCELÁNICO  
EXTRUDED PORCELAIN TILE

CLASE I - R 9  
UNE-EN-16165  
ANEXO C - B



MATE  
MATT



BRILLO  
GLOSS



Pav. / Floor: Cotto Nature Sicilia Olio 36x36 - Losanga Cotto Nature Sicilia Olio 18x36 - Star Venice A, B y C 18x18 - Taco Venice 5x5



Pav. / Floor: Cotto Nature Cerdeña 36x36 - Cotto Nature Cerdeña 18x36 - Cotto Nature Cerdeña 18x18



COTTO NATURE SICILIA



COTTO NATURE SIENA



COTTO NATURE CERDEÑA

CLASE I - R 9

ESPECIFICACIONES TÉCNICAS - TECHNICAL SPECIFICATIONS



COTTO NATURE SICILIA OLIO



COTTO NATURE SIENA OLIO



COTTO NATURE CERDEÑA OLIO

CLASE I

ESPECIFICACIONES TÉCNICAS - TECHNICAL SPECIFICATIONS

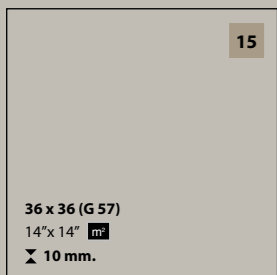

36 x 36 (G 57)  
14" x 14"  $m^2$   
10 mm.

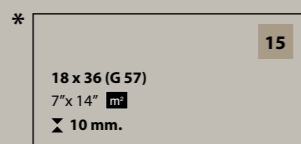

18 x 36 (G 57)  
7" x 14"  $m^2$   
10 mm.

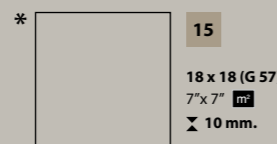

18 x 18 (G 57)  
7" x 7"  $m^2$   
10 mm.

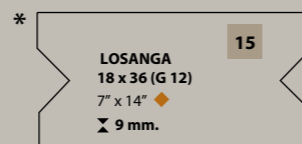

LOSANGA  
18 x 36 (G 12)  
7" x 14"  $m^2$   
9 mm.

\* LOSANGA NO disponible en CERDEÑA OLIO y SIENA OLIO  
\* LOSANGA NOT available in CERDEÑA OLIO & SIENA OLIO

PIEZAS ESPECIALES - SPECIAL PIECES

Solo disponible en acabado MATE - Only available in MATT finish



PELDAÑO CURVO  
36 x 33/4 (G 18) 14" x 13 7/16"  $m^2$

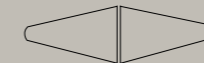

ÁNG. PELDAÑO CURVO  
33 x 46/4 (G 19 x 2PZ)  
13" x 18 1/16"  $m^2$



ZÓCALO  
9 x 36 (G 607)  
3,5" x 14"  $m^2$

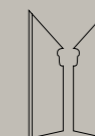

ZANQUÍN CV. - IZQ. / DCHA.  
9 x 36 (G 10)  
3,5" x 14"  $m^2$



ZÓCALO  
9 x 30 (G 06)  
3,5" x 11,8"  $m^2$

PIEZAS ESPECIALES OLIO  
SPECIAL PIECES OLIO

# PIEMONTE

EXTRUSIONADO PORCELÁNICO  
EXTRUDED PORCELAIN TILE

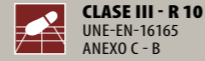

Pav. / Floor: Piemonte Torino Antislip 36x36 - Losanga Piemonte Torino Antislip 15,5x36 - Estrella Versilia A,B,C y D 15,5x15,5



Pav. / Floor: Piemonte Asti Antislip 36x36 - Losanga Piemonte Asti Antislip 15,5x36 - Star Piemonte Asti Antislip 15,5x15,5 - Taco Piemonte Asti Antislip 4x4  
Rev. / Wall: Heritage Clay Ivory 120x120



PIEMONTE TORINO ANTISLIP



PIEMONTE NOVARA ANTISLIP



PIEMONTE ASTI ANTISLIP

## ESPECIFICACIONES TÉCNICAS - TECHNICAL SPECIFICATIONS



RESISTE LA FLEXIÓN  
29 N/mm<sup>2</sup>

RESISTE EL DESGASTE  
PEI (III - IV)

RESISTE EL RAYADO  
MOHS - 8

MANCHAS  
Clase 5  
Clase A

ABSORCIÓN  
0,1%

DILATACIÓN  
6,1\* 10<sup>-6</sup> /°C

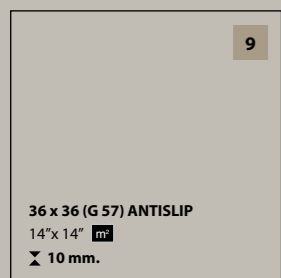

36 x 36 (G 57) ANTISLIP  
14" x 14" <sup>mm</sup>  
10 mm.



9  
LOSANGA  
15,5 x 36 (G 11) ANTISLIP  
6" x 14" <sup>mm</sup>  
10 mm.

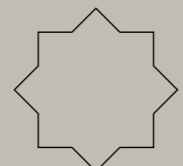

9  
STAR  
15,5 x 15,5 (G 12) ANTISLIP  
6" x 6" <sup>mm</sup>  
10 mm.



9  
TACO  
4 x 4 (G 01) ANTISLIP  
1,5" x 1,5" <sup>mm</sup>  
10 mm.

## PIEZAS ESPECIALES - SPECIAL PIECES



PELDAÑO CURVO ANTISLIP  
36 x 33/4 (G 18) 14" x 13 1/4"

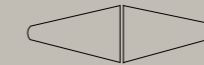

ÁNG. PELDAÑO CURVO ANTISLIP  
33 x 46/4 (G 19 x 2PZ) 13" x 18 1/4"

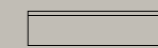

ZÓCALO  
9 x 36 (G 07) 3,5" x 14"

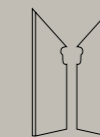

ZANQUÍN CV. - IZQ. / DCHA.  
9 x 36 (G 10) 3,5" x 14"



ESTRELLA VERSILIA A  
15,5 x 15,5 (G 31) 6" x 6" <sup>mm</sup>  
18 x 18 (G 18) 7" x 7" <sup>mm</sup>



ESTRELLA VERSILIA B  
15,5 x 15,5 (G 31) 6" x 6" <sup>mm</sup>  
18 x 18 (G 18) 7" x 7" <sup>mm</sup>



ESTRELLA VERSILIA C  
15,5 x 15,5 (G 31) 6" x 6" <sup>mm</sup>  
18 x 18 (G 18) 7" x 7" <sup>mm</sup>



ESTRELLA VERSILIA D  
15,5 x 15,5 (G 31) 6" x 6" <sup>mm</sup>  
18 x 18 (G 18) 7" x 7" <sup>mm</sup>



FRONTAL VERSILIA  
15,5 x 36 (G 21) 6" x 14" <sup>mm</sup>



TIRA VERSILIA  
8 x 36 (G 18) 3" x 14" <sup>mm</sup>



TACO VERSILIA B  
8 x 8 (G 12) 3" x 3" <sup>mm</sup>



TACO VERSILIA  
8 x 8 (G 12) 3" x 3" <sup>mm</sup>



TACO VERSILIA  
5 x 5 (G 04) 2" x 2" <sup>mm</sup>



TACO VERSILIA  
4 x 4 (G 04) 1,5" x 1,5" <sup>mm</sup>

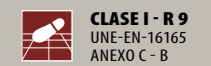

# PIEMONTE

EXTRUSIONADO PORCELÁNICO  
EXTRUDED PORCELAIN TILE

CLASE I - R 9  
UNE-EN-16165  
ANEXO C - B



Pav. / Floor: Piemonte Alessandria 36x36 - Piemonte Alessandria 18x36 - Piemonte Alessandria 18x18



Pav. / Floor: Piemonte Biella 36x36



PIEMONTE ALESSANDRIA



PIEMONTE BIELLA



PIEMONTE VERCELLI

## ESPECIFICACIONES TÉCNICAS - TECHNICAL SPECIFICATIONS



RESISTE LA FLEXIÓN  
29 N/mn<sup>2</sup>



RESISTE EL DESGASTE  
PEI (II - IV)



RESISTE EL RAYADO  
MOHS-5



MANCHAS  
Clase 5  
Clase A



ABSORCIÓN  
0,2%



DILATACIÓN  
5,7\* 10<sup>-4</sup> /°C

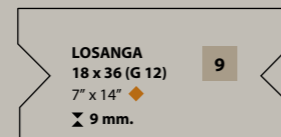
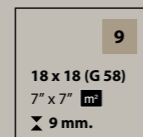
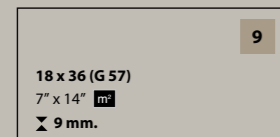
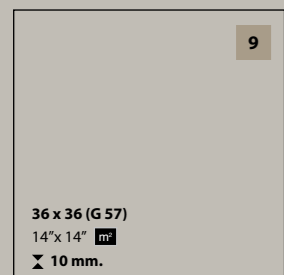

ESTRELLA VERSILIA A  
15,5 x 15,5 (G 31) 6" x 6"  
18 x 18 (G 18) 7" x 7"



ESTRELLA VERSILIA B  
15,5 x 15,5 (G 31) 6" x 6"  
18 x 18 (G 18) 7" x 7"



ESTRELLA VERSILIA C  
15,5 x 15,5 (G 31) 6" x 6"  
18 x 18 (G 18) 7" x 7"

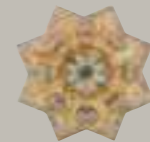

ESTRELLA VERSILIA D  
15,5 x 15,5 (G 31) 6" x 6"  
18 x 18 (G 18) 7" x 7"



FRONTAL VERSILIA  
15,5 x 36 (G 21) 6" x 14"



TIRA VERSILIA  
8 x 36 (G 18) 3" x 14"



TACO VERSILIA B  
8 x 8 (G 12) 3" x 3"



TACO VERSILIA  
8 x 8 (G 12) 3" x 3"



TACO VERSILIA  
5 x 5 (G 04) 2" x 2"



TACO VERSILIA  
4 x 4 (G 04) 1,5" x 1,5"

# TECH-LAND

EXTRUSIONADO PORCELÁNICO  
EXTRUDED PORCELAIN TILE

**CLASE III - R 11**  
UNE-EN-16165  
ANEXO C - B

**CLASS C**  
UNE-EN-16165  
ANEXO A

**14 mm**  
ESPESOR  
THICKNESS



Pav. / Floor: **Tech Land Fire Antislip 11x22,5** - Peldaño Curvo **Tech Land Fire Antislip 30x33/4**  
Rev. / Wall: **Boston Brick Downtown 6,5x25**



Pav. / Floor: **Tech Land Natural Antislip 22,5x22,5** - Peldaño Curvo **Tech Land Natural Antislip 30x33/4** - Borde Piscina **Tech Land Natural Antislip 28x66,5/4** - Esquina Interior Borde Piscina **Tech Land Natural Antislip 28x66,5x43/4**



**TECH LAND FIRE**  
ANTISLIP



**TECH LAND NATURAL**  
ANTISLIP

## ESPECIFICACIONES TÉCNICAS - TECHNICAL SPECIFICATIONS

<b>RESISTE LA FLEXIÓN</b> 89 N/mn <sup>2</sup>	<b>RESISTE EL DESGASTE</b> PEI (II - III)	<b>RESISTE EL RAYADO</b> MOHS - 8	<b>MANCHAS</b> Clase 5 Clase A	<b>ABSORCIÓN</b> 0,3%	<b>DILATACIÓN</b> 6,6° 10° / °C	<b>FUERZA DE ROTURA</b> 3119 Nw	<b>CARGA DE ROTURA</b> 3408 Nw

**22,5 x 22,5 (G 58)**  
**ANTISLIP**  
8,8" x 8,8"   
14 mm.

**30 x 30 (G 38)**  
**ANTISLIP**  
11,8" x 11,8"   
14 mm.

**22,5 x 33 (G 58)**  
**ANTISLIP**  
8,8" x 13"   
14 mm.

**11 x 22,5 (G 58)**  
**ANTISLIP**  
4,3" x 8,8"   
14 mm.

\* Solo disponible en FIRE  
Only available in FIRE

## PIEZAS ESPECIALES - SPECIAL PIECES

**PELDAÑO CURVO ANTISLIP**  
30 x 33/4 (G 17) 11,8" x 13"/1,5" ◆

**ÁNG. PELDAÑO CURVO ANTISLIP**  
33 x 46/4 (G 19 x 2PZ) 13" x 18"/1,5" ◆

**ÁNG. PELD. CURVO ANTISLIP 4PZ.**  
33 x 33/4 (G 78 x juego) 13" x 13"/1,5" ◆

**VIERTEAGUAS ANTISLIP**  
15 x 30/4 (G 12) 5,9" x 11,8"/1,5" ◆

**ZANQUÍN CV. - IZQ. / DCHA.**  
9 x 30 (G 10) 3,5" x 11,8" ◆

**BORDE PISCINA ANTISLIP**  
28 x 66,5/4 (G 80) 10" x 26,5"/1,5" ◆

**ESQUINA INT. BORDE PISCINA ANTISLIP**  
28 x 66,5 x 43/4 (G 56 x 2PZ)  
10" x 26,5" x 17"/1,5" ◆

**ESQUINA EXT. BORDE PISCINA ANTISLIP**  
28 x 66,5 x 43/4 (G 56 x 2PZ)  
10" x 26,5" x 17"/1,5" ◆

**ZÓCALO**  
9 x 30 (G 06) 3,5" x 11,8" ◆

# TECH-LAND

EXTRUSIONADO PORCELÁNICO  
EXTRUDED PORCELAIN TILE

CLASE III - R 11  
UNE-EN-16165  
ANEXO C - B

CLASS C  
UNE-EN-16165  
ANEXO A

14 mm  
ESPESOR  
THICKNESS



Pav. / Floor: Tech Land Temple Fire Antislip 22,5x22,5  
Tech Land Fire Antislip 22,5x33 · Tech Land Fire Antislip 11x22,5



Pav. / Floor: Tech Land Coat Fire Antislip 22,5x22,5 · Tech Land Fire Antislip 22,5x22,5



Pav. / Floor: Tech Land Temple Natural Antislip 22,5x22,5



TECH LAND TEMPLE FIRE ANTISLIP 22,5 x 22,5 (G 56) 8,8" x 8,8" m<sup>2</sup>  
14 mm.

17



TECH LAND COAT FIRE ANTISLIP 22,5 x 22,5 (G 56) 8,8" x 8,8" m<sup>2</sup>  
14 mm.

17



TECH LAND TEMPLE NATURAL ANTISLIP 22,5 x 22,5 (G 56) 8,8" x 8,8" m<sup>2</sup>  
14 mm.

17

# TECH-LAND

EXTRUSIONADO PORCELÁNICO  
EXTRUDED PORCELAIN TILE

CLASE III - R 11  
UNE-EN-16165  
ANEXO C - B

CLASS C  
UNE-EN-16165  
ANEXO A

14 mm  
ESPESOR  
THICKNESS



Pav. / Floor: Tech Land Star Temple Fire Antislip 15,5x15,5 - Tech Land Cross Fire Antislip 15,5x15,5



Pav. / Floor: Tech Land Star Fire Antislip 15,5x15,5 - Tech Land Cross Fire Antislip 15,5x15,5



17

TECH LAND STAR FIRE ANTISLIP  
15,5 x 15,5 (G 52) 6" x 6" m  
14 mm.



17

TECH LAND STAR TEMPLE FIRE ANTISLIP  
15,5 x 15,5 (G 52) 6" x 6" m  
14 mm.



17

TECH LAND CROSS FIRE ANTISLIP  
15,5 x 15,5 (G 52) 6" x 6" m  
14 mm.



17

TECH LAND CROSS TEMPLE FIRE ANTISLIP  
15,5 x 15,5 (G 52) 6" x 6" m  
14 mm.



TECH LAND CROSS FIRE ANTISLIP  
TECH LAND STAR TEMPLE FIRE ANTISLIP



TECH LAND CROSS TEMPLE FIRE ANTISLIP  
TECH LAND STAR TEMPLE FIRE ANTISLIP



TECH LAND CROSS FIRE ANTISLIP  
TECH LAND STAR FIRE ANTISLIP

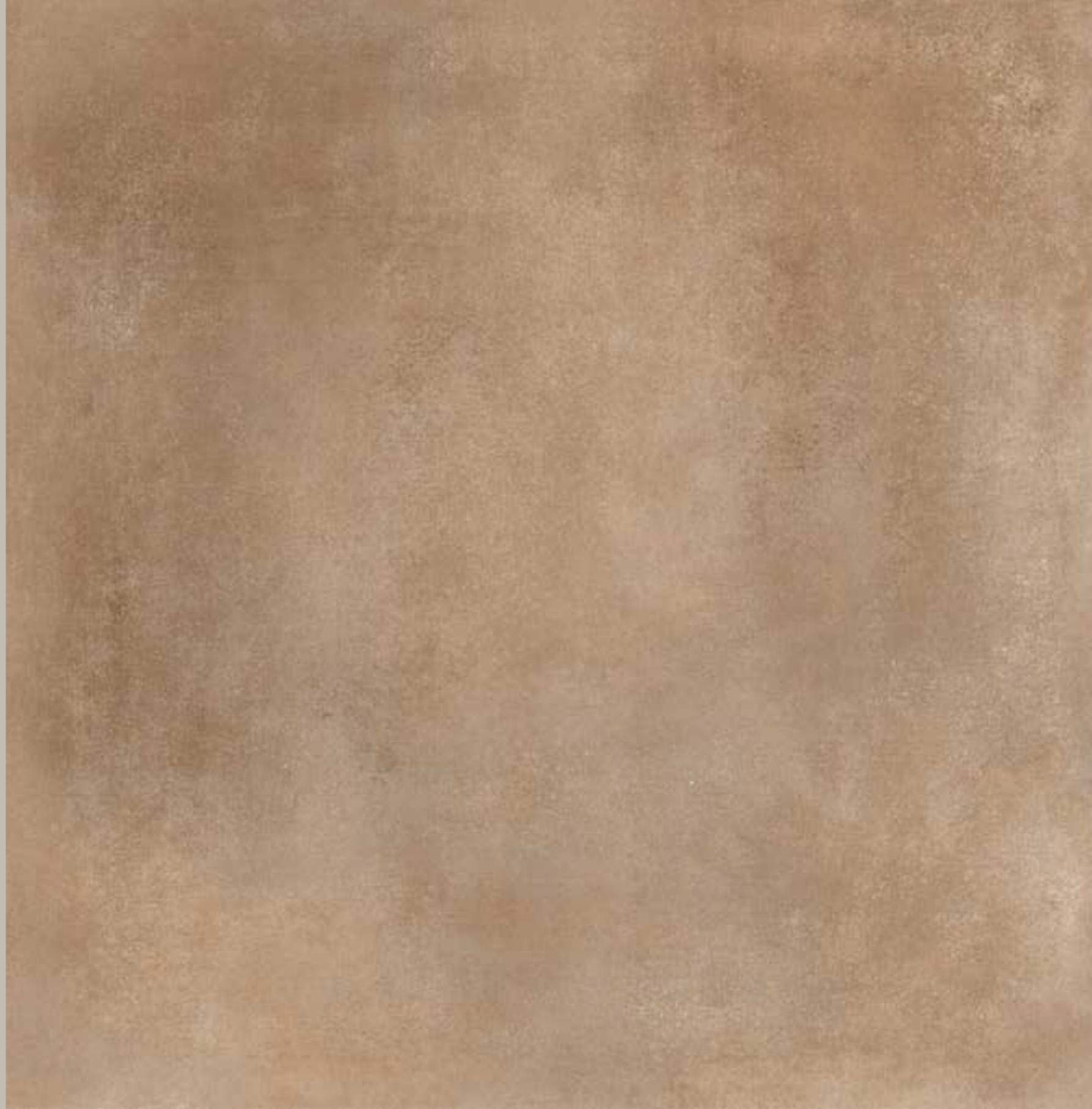

Heritage Clay Cotto 120x120 · Heritage Clay Cotto 60x120 · Heritage Clay Cotto 60x60

**HERITAGE CLAY, la esencia de la piedra llevada al lenguaje cerámico.**  
*HERITAGE CLAY, the essence of stone translated into ceramic language.*

# HERITAGE CLAY



NATUCER  
*cerámica natural*

NEW  
2026

 **matera**  
BEYOND THE SURFACE

# HERITAGE CLAY

Matera es la nueva tecnología de Natucer que eleva el porcelánico mediante la combinación de diseño y precisión tecnológica, creando superficies con carácter propio. Su propuesta **multiformato** y acabados premium ofrece a diseñadores y arquitectos nuevas posibilidades para desarrollar espacios con identidad y sofisticación.

Destaca por su calidad, durabilidad e innovación, consolidándose como un referente en el diseño cerámico. Además, su gama de **piezas especiales** garantizan **continuidad visual** y acabados envolventes en suelos, revestimientos, coronaciones e incluso piscinas.

Matera is Natucer's new technology that elevates porcelain stoneware by combining design and technological precision, creating surfaces with distinctive character. Its multi-format approach and premium finishes offer designers and architects new possibilities to develop spaces with identity and sophistication.

It stands out for its quality, durability, and innovation, establishing itself as a benchmark in ceramic design. In addition, its range of special pieces ensures visual continuity and seamless finishes in floors, wall coverings, coping, and even swimming pools.

**NATUCER**  
cerámica natural



Pav. / Floor: **Heritage Clay Cotto 120x120**  
Rev. / Wall: **Heritage Clay Cotto 120x120**

NEW  
2026

# HERITAGE CLAY

HERITAGE CLAY es una nueva serie inspirada en la piedra natural, disponible en 7 colores diferentes. Su diseño destaca por la modularidad de sus piezas y la continuidad de textura y volumen entre todas ellas, logrando una armonía visual fluida y coherente en cualquier espacio.

HERITAGE CLAY is a new stone-inspired ceramic series available in 7 different colors. Its design stands out for the modularity of its pieces and the continuity of texture and volume across all formats, creating a smooth and cohesive visual harmony in any space.



# HERITAGE CLAY

PORCELÁNICO RECTIFICADO  
RECTIFIED PORCELAIN TILE

NEW  
2026

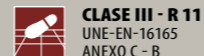
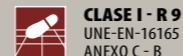

HERITAGE CLAY WHITE  
HERITAGE CLAY WHITE  
ANTISLIP

HERITAGE CLAY IVORY  
HERITAGE CLAY IVORY  
ANTISLIP

HERITAGE CLAY PEARL  
HERITAGE CLAY PEARL  
ANTISLIP

HERITAGE CLAY GREIGE  
HERITAGE CLAY GREIGE  
ANTISLIP

HERITAGE CLAY COTTO  
HERITAGE CLAY COTTO  
ANTISLIP

HERITAGE CLAY BLUE

HERITAGE CLAY EMERALD

Colores BLUE y EMERALD solo disponibles en CLASE I - R9  
BLUE & EMERALD colors only available in CLASS I - R9

**120 x 120 (G 80)**  
**120 x 120 (G 80) ANTISLIP**  
48" x 48"  $m^2$   
± 8 mm.

**9**

**60 x 120 (G 86)**  
**60 x 120 (G 79) ANTISLIP**  
24" x 48"  $m^2$   
± 8 mm.

**9**

\*

**9**

\*

**9**

**30 x 30 (5x5) (G 16)**  
12" x 12" (2" x 2")  $m^2$   
± 8 mm.

**15 x 15 (G 68)**  
6" x 6"  $m^2$   
± 8 mm.

**6,5 x 20 (G 68)**  
2,5" x 8"  $m^2$   
± 8 mm.

**60 x 60 (G 73)**  
**60 x 60 (G 86) ANTISLIP**  
24" x 24"  $m^2$   
± 8 mm.

**9**

**30 x 60 (G 73)**  
**30 x 60 (G 86) ANTISLIP**  
12" x 24"  $m^2$   
± 8 mm.

**9**



Pav. / Floor: Heritage Clay Blue 120x120  
Rev. / Wall: Heritage Clay White 120x120 - Heritage Clay Blue 6,5x20



Pav. / Floor: Heritage Clay White 120x120 - Sherwood Linde 20x120 - Peldaño Recto Sherwood Linde 120x33/3  
Rev. / Wall: Lineage White 6,5x20

# HERITAGE CLAY

PORCELÁNICO RECTIFICADO  
RECTIFIED PORCELAIN TILE

NEW  
2026

**matera**  
REFINING THE SURFACE



EXTRUSIONADO PORCELÁNICO  
EXTRUDED PORCELAIN TILE



PIEZAS ESPECIALES · SPECIAL PIECES  
Disponible en WHITE, IVORY, PEARL, GREIGE y COTTO - Available in WHITE, IVORY, PEARL, GREIGE & COTTO

**CLASE III - R 11**  
UNE-EN-16165  
ANEXO C - B

PELDAÑO BLOCK

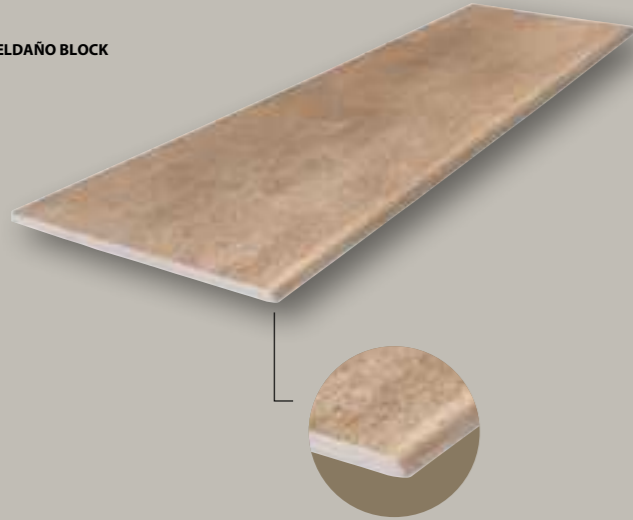

BORDE PISCINA

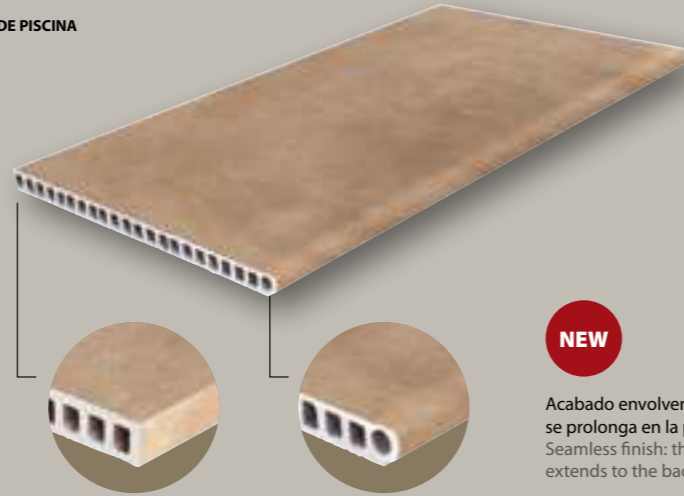

NEW

Acabado envolverte: el diseño se prolonga en la parte trasera.  
Seamless finish: the design extends to the back.

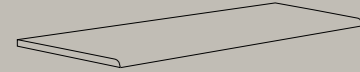

**PELDAÑO BLOCK ANTISLIP**  
120 x 33/1,4 (G 79) 48" x 13"/0,5"



**BORDE PISCINA ANTISLIP**  
45 x 120/3 (G 83) 17,7" x 48"/1"  
45 x 60/3 (G 80) 17,7" x 23,6"/1"

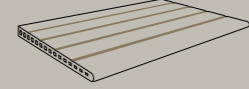

**DESBORDANTE ANTISLIP**  
30,5 x 50/2,4 (G 80)  
11,8" x 20"/1"

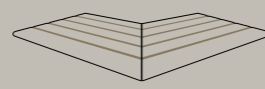

**ESQ. EXT. DESBORDANTE ANTISLIP**  
30,5 x 50 x 40/2,4 (G 56 x 2PZ)  
11,8" x 20" x 16"/1"

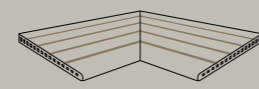

**ESQ. INT. DESBORDANTE ANTISLIP**  
30,5 x 50 x 40/2,4 (G 56 x 2PZ)  
11,8" x 20" x 16"/1"

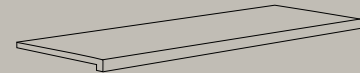

**PELDAÑO RECTO ANTISLIP**  
120 x 32/3 (G 72) 48" x 12,5"/1"  
60 x 32/3 (G 73) 23,6" x 12,5"/1"



**GRATTING ANTISLIP**  
25 x 50/2,2 (G 78)  
10" x 20"/1"

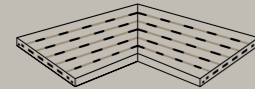

**ÁNG. GRATTING ANTISLIP**  
25 x 50 x 35/2,2 (G 60 x 2PZ)  
10" x 20" x 15"/1"



**SISTEMA GRATTING SIN IMPACTO**  
NON IMPACT GRATTING SYSTEM  
SYSTÈME DE GRATTEGE SANS IMPACT



**GOMA PARA GRATTING / GRATTING RUBBER**  
22,5 x 1,7 · 8,8" x 0,4"  
(SE NECESITAN 2 ud. POR GRATTING)

**ÁNG. PELDAÑO RECTO EXT. / INT. ANTISLIP**  
120 x 32 x 45/3 (G 46 x 2PZ)  
48" x 12,5" x 17,7"/1"

EXTRUSIONADO PORCELÁNICO  
EXTRUDED PORCELAIN TILE



PIEZAS ESPECIALES · SPECIAL PIECES  
Disponible en WHITE, BLUE y EMERALD - Available in WHITE, BLUE & EMERALD



**CUBRECANTO**  
4 x 30 x 4 (G 15) 1,5" x 11,8" x 1,5"



**COMP. EXT. CUBRECANTO**  
4 x 4 (G 17) 1,5" x 1,5"



**COMP. INT. CUBRECANTO**  
4 x 4 (G 17) 1,5" x 1,5"

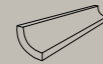

**MEDIA CAÑA INT.**  
4 x 30 x 4 (G 13) 1,5" x 11,8" x 1,5"



**COMP. INT. MEDIA CAÑA**  
4 x 4 (G 17) 1,5" x 1,5"



**COMP. EXT. MEDIA CAÑA**  
4 x 4 (G 17) 1,5" x 1,5"

EXTRUSIONADO PORCELÁNICO  
EXTRUDED PORCELAIN TILE



PIEZAS ESPECIALES · SPECIAL PIECES  
Disponible en todos los colores - Available in all colors

**CLASE I - R 9**  
UNE-EN-16165  
ANEXO C - B



**PELDAÑO RECTO**  
120 x 32/3 (G 72) 48" x 12,5"/1"  
60 x 32/3 (G 73) 23,6" x 12,5"/1"

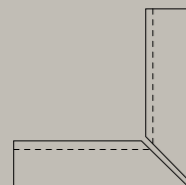

**ÁNG. PELDAÑO RECTO INT.**  
120 x 32 x 45/3 (G 46 x 2PZ)  
48" x 12,5" x 17,7"/1"

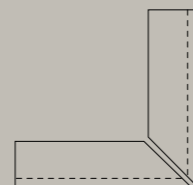

**ÁNG. PELDAÑO RECTO EXT.**  
120 x 32 x 45/3 (G 46 x 2PZ)  
48" x 12,5" x 17,7"/1"



**FRONTAL**  
15 x 120 (G 74) 6" x 48"



**ZÓCALO**  
9,8 x 120 (G 74) 4" x 48"  
9,8 x 60 (G 75) 4" x 23,6"



Pav. / Floor: Heritage Clay Cotto 120x120 · Peldaño Recto Heritage Clay Cotto 120x32/3 · Frontal Heritage Clay Cotto 15x120

# HERITAGE CLAY 20mm

PORCELÁNICO RECTIFICADO  
RECTIFIED PORCELAIN TILE

NEW  
2026

matera  
BETWEEN THE SURFACES

CLASE III - R 11  
UNE-EN-16165  
ANEXO C - B

20 mm  
ESPESOR  
THICKNESS



BORDES RECTIFICADOS - Rectified Edges



HERITAGE CLAY WHITE ANTISLIP  
60 x 120 x 2 (G 76) 24" x 48" x 1" **m²**  
20 mm.

9



HERITAGE CLAY IVORY ANTISLIP  
60 x 120 x 2 (G 76) 24" x 48" x 1" **m²**  
20 mm.

9



HERITAGE CLAY GREIGE ANTISLIP  
60 x 120 x 2 (G 76) 24" x 48" x 1" **m²**  
20 mm.

9

BORDES IRREGULARES - Irregular Edges



HERITAGE CLAY WHITE ANTISLIP  
60 x 90 x 2 (G 79) 24" x 36" x 1" **m²**  
20 mm.

9



HERITAGE CLAY IVORY ANTISLIP  
60 x 90 x 2 (G 79) 24" x 36" x 1" **m²**  
20 mm.

9



HERITAGE CLAY GREIGE ANTISLIP  
60 x 90 x 2 (G 79) 24" x 36" x 1" **m²**  
20 mm.

9



Colocación mínima recomendada de PLOTS para los formatos  
60x120 Rec. y 60x90 con espesor de 20mm.  
Placement of the minimum recommended PLOTS 60x120 Rec.  
and 60x90 with a thickness of 20 mm.



Esquema de montaje con baldosas  
Mounting scheme with tiles

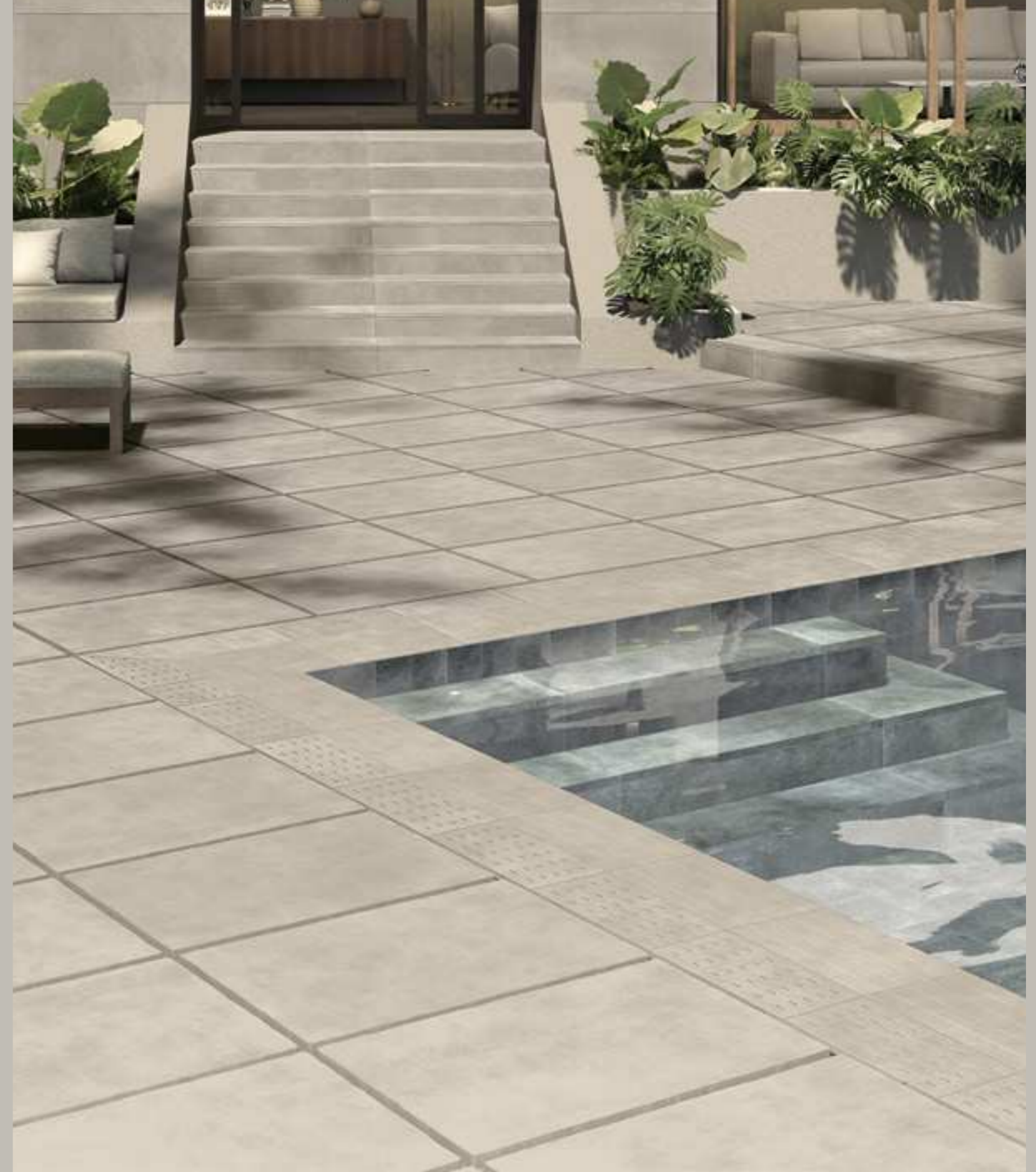
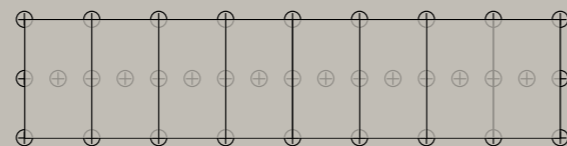

Pav. / Floor: Heritage Clay Greige Antislip 60x90x2 · Peldaño Recto Heritage Clay Greige Antislip 120x32/3 · Frontal Heritage Clay Greige 15x120 · Grating Heritage Clay Greige Antislip 25x50/2,2  
Ángulo Grating Heritage Clay Greige Antislip 25x50x35/2,2 · Desbordante Heritage Clay Greige Antislip 30,5x50/2,4 · Esq. Int. Desbordante Heritage Clay Greige Antislip 30,5x50x40/2,4  
Vaso Piscina / Pool Basin: Heritage Clay Emerald 15x15 · Peldaño Recto Heritage Clay Emerald 120x32/3 · Frontal Heritage Clay Emerald 15x120  
Rev. / Wall: Heritage Clay Greige 60x120

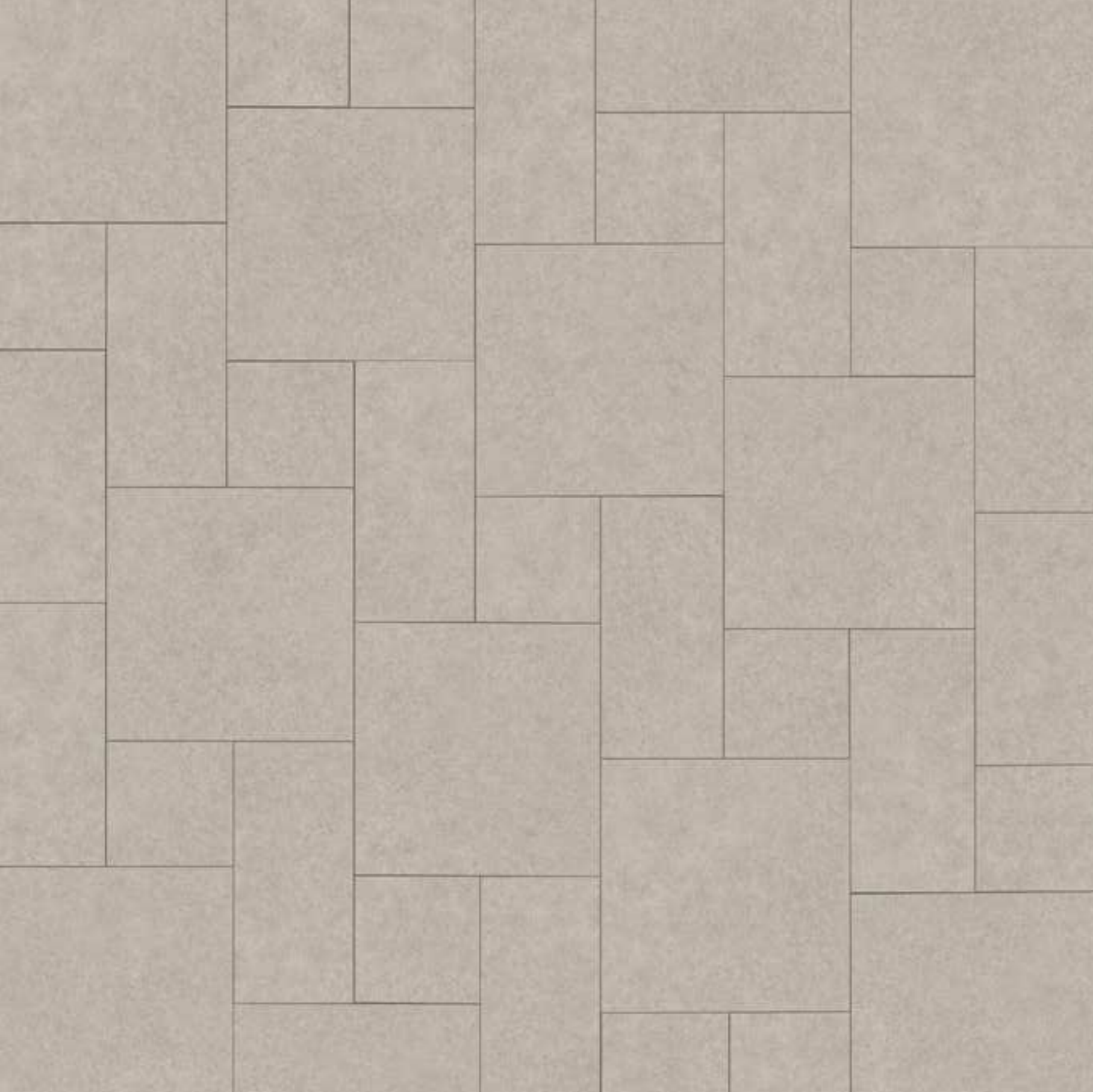

Sarsen Stone Greige 120x120 - Sarsen Stone Greige 60x120 - Sarsen Stone Greige 60x60

**SARSEN STONE, la calma de la piedra en diseño actual.**  
*SARSEN STONE, the calmness of stone in contemporary design.*

# SARSEN STONE



NATUCER  
*cerámica natural*

NEW  
2026

**matera**  
BEYOND THE SURFACE

# SARSEN STONE

Matera es la nueva tecnología de Natucer que eleva el porcelánico mediante la combinación de diseño y precisión tecnológica, creando superficies con carácter propio. Su propuesta **multiformato** y acabados premium ofrece a diseñadores y arquitectos nuevas posibilidades para desarrollar espacios con identidad y sofisticación.

Destaca por su calidad, durabilidad e innovación, consolidándose como un referente en el diseño cerámico. Además, su gama de piezas especiales garantizan **continuidad visual** y acabados envolventes en suelos, revestimientos, coronaciones e incluso piscinas.

Matera is Natucer's new technology that elevates porcelain stoneware by combining design and technological precision, creating surfaces with distinctive character. Its multi-format approach and premium finishes offer designers and architects new possibilities to develop spaces with identity and sophistication.

It stands out for its quality, durability, and innovation, establishing itself as a benchmark in ceramic design. In addition, its range of special pieces ensures visual continuity and seamless finishes in floors, wall coverings, coping, and even swimming pools.

NATUCER  
cerámica natural



Pav. / Floor: Sarsen Stone Greige 120x120 - Sarsen Stone Greige 60x120 - Sarsen Stone Greige 60x60  
Rev. / Wall: Sarsen Stone Greige 60x120 - Sarsen Stone White 15x15

NEW  
2026

# SARSEN STONE

SARSEN STONE es una serie inspirada en la piedra, con una cuidada paleta de colores neutros. Su diseño transmite equilibrio y naturalidad, dando lugar a superficies serenas y atemporales que se integran con elegancia en cualquier espacio, tanto interior como exterior.

SARSEN STONE is a series inspired by stone, featuring a carefully chosen neutral color palette. Its design conveys balance and naturalness, creating serene and timeless surfaces that integrate elegantly into any space, both indoors and outdoors.



# SARSEN STONE

PORCELÁNICO RECTIFICADO  
RECTIFIED PORCELAIN TILE

NEW  
2026

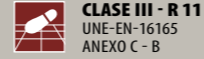

SARSEN STONE WHITE  
SARSEN STONE WHITE ANTISLIP  
\* 15 x 15 - 6" x 6" - CLASE I - R9  
\* 5 x 25 - 2" x 10" - CLASE I - R9

SARSEN STONE IVORY  
SARSEN STONE IVORY ANTISLIP

SARSEN STONE GREIGE  
SARSEN STONE GREIGE ANTISLIP

CLASE I - R9  
160 x 160 (G 55)  
64" x 64"   
⊗ 8 mm.

CLASE I - R 9  
UNE-EN-16165  
ANEXO C - B

6

120 x 120 (G 80)  
120 x 120 (G 80) ANTISLIP  
48" x 48"   
⊗ 8 mm.

6

60 x 120 (G 86)  
60 x 120 (G 79) ANTISLIP  
24" x 48"   
⊗ 8 mm.

6

6

30 x 30 (5x5) (G 16)  
12" x 12" (2" x 2")   
⊗ 8 mm.

30 x 60 (G 73)  
30 x 60 (G 86) ANTISLIP  
12" x 24"   
⊗ 8 mm.

6

60 x 60 (G 73)  
60 x 60 (G 86) ANTISLIP  
24" x 24"   
⊗ 8 mm.

6



Pav. / Floor: Sarsen Stone Greige Antislip 120x120 - Borde Piscina Antislip 45x120/3 - Peldaño Block Antislip 120x33/1,4 - Sarsen Stone Greige Antislip 60x120x2  
Vaso Piscina / Pool Basin: Sarsen Stone Turquoise Bali 15x15

\* CLASE I - R 9  
UNE-EN-16165  
ANEXO C - B

\* 6  
15 x 15 (G 68)  
6" x 6"   
⊗ 8 mm.



SARSEN STONE  
WHITE



SARSEN STONE  
TURQUOISE BALI

\* 15x15 solo disponible en WHITE y TURQUOISE BALI  
\* 6"x6" only available in WHITE & TURQUOISE BALI

\* 6  
5 x 25 (G 68) 2" x 10"   
⊗ 8 mm.

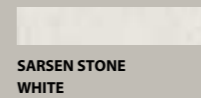

SARSEN STONE  
WHITE

\* 5x25 solo disponible en WHITE  
\* 2"x10" only available in WHITE

# SARSEN STONE

PORCELÁNICO RECTIFICADO  
RECTIFIED PORCELAIN TILE

NEW  
2026



EXTRUSIONADO PORCELÁNICO  
EXTRUDED PORCELAIN TILE



PIEZAS ESPECIALES - SPECIAL PIECES  
Disponible en WHITE, IVORY y GREIGE - Available in WHITE, IVORY & GREIGE

CLASE III - R 11  
UNE-EN-16165  
ANEXO C - B

PELDAÑO BLOCK

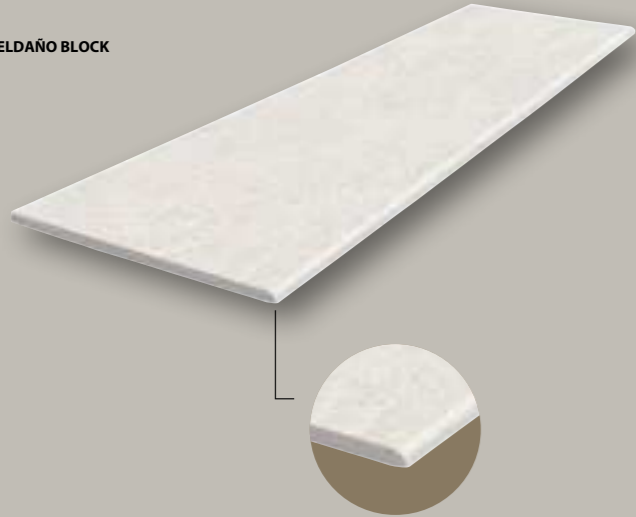

BORDE PISCINA



NEW

Acabado envolvente: el diseño se prolonga en la parte trasera.  
Seamless finish: the design extends to the back.

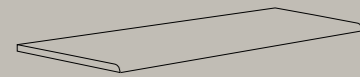

PELDAÑO BLOCK ANTISLIP  
120 x 33/1,4 (G 79) 48" x 13"/0,5"



BORDE PISCINA ANTISLIP  
45 x 120/3 (G 83) 17,7" x 48"/1"  
45 x 60/3 (G 80) 17,7" x 23,6"/1"

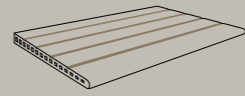

DESBORDANTE ANTISLIP  
30,5 x 50/2,4 (G 80)  
11,8" x 20"/1"

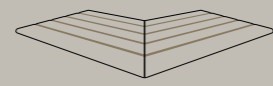

ESQ. EXT. DESBORDANTE ANTISLIP  
30,5 x 50 x 40/2,4 (G 56 x 2PZ)  
11,8" x 20" x 16"/1"

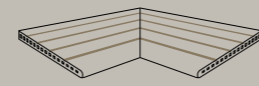

ESQ. INT. DESBORDANTE ANTISLIP  
30,5 x 50 x 40/2,4 (G 56 x 2PZ)  
11,8" x 20" x 16"/1"



PELDAÑO RECTO ANTISLIP  
120 x 32/3 (G 72) 48" x 12,5"/1"  
60 x 32/3 (G 73) 23,6" x 12,5"/1"



GRATTING ANTISLIP  
25 x 50/2,2 (G 78)  
10" x 20"/1"

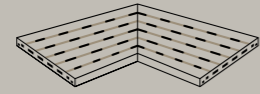

ÁNG. GRATTING ANTISLIP  
25 x 50 x 35/2,2 (G 60 x 2PZ)  
10" x 20" x 15"/1"



SISTEMA GRATTING SIN IMPACTO  
NON IMPACT GRATTING SYSTEM  
SYSTÈME DE GRATTAGE SANS IMPACT



GOMA PARA GRATTING / GRATTING RUBBER  
22,5 x 1,7 - 8,8" x 0,4"  
(SE NECESITAN 2 ud. POR GRATTING)

ÁNG. PELDAÑO RECTO EXT. / INT. ANTISLIP  
120 x 32 x 45/3 (G 46 x 2PZ)  
48" x 12,5" x 17,7"/1"

EXTRUSIONADO PORCELÁNICO  
EXTRUDED PORCELAIN TILE



PIEZAS ESPECIALES - SPECIAL PIECES  
Disponible en WHITE, IVORY y TURQUOISE BALI - Available in WHITE & IVORY



CUBRECANTO  
4 x 30 x 4 (G 15) 1,5" x 11,8" x 1,5"



COMP. EXT. CUBRECANTO  
4 x 4 (G 17) 1,5" x 1,5"



COMP. INT. CUBRECANTO  
4 x 4 (G 17) 1,5" x 1,5"

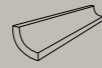

MEDIA CAÑA INT.  
4 x 30 x 4 (G 13) 1,5" x 11,8" x 1,5"



COMP. INT. MEDIA CAÑA  
4 x 4 (G 17) 1,5" x 1,5"



COMP. EXT. MEDIA CAÑA  
4 x 4 (G 17) 1,5" x 1,5"

EXTRUSIONADO PORCELÁNICO  
EXTRUDED PORCELAIN TILE



PIEZAS ESPECIALES - SPECIAL PIECES  
Disponible en WHITE, IVORY y GREIGE - Available in WHITE, IVORY & GREIGE

CLASE I - R 9  
UNE-EN-16165  
ANEXO C - B

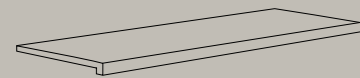

PELDAÑO RECTO  
120 x 32/3 (G 72) 48" x 12,5"/1"  
60 x 32/3 (G 73) 23,6" x 12,5"/1"

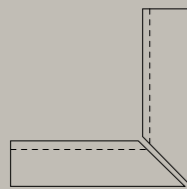

ÁNG. PELDAÑO RECTO INT.  
120 x 32 x 45/3 (G 46 x 2PZ)  
48" x 12,5" x 17,7"/1"

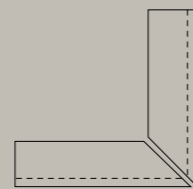

ÁNG. PELDAÑO RECTO EXT.  
120 x 32 x 45/3 (G 46 x 2PZ)  
48" x 12,5" x 17,7"/1"



FRONTAL  
15 x 120 (G 74) 6" x 48"



ZÓCALO  
9,8 x 120 (G 74) 4" x 48"  
9,8 x 60 (G 75) 4" x 23,6"

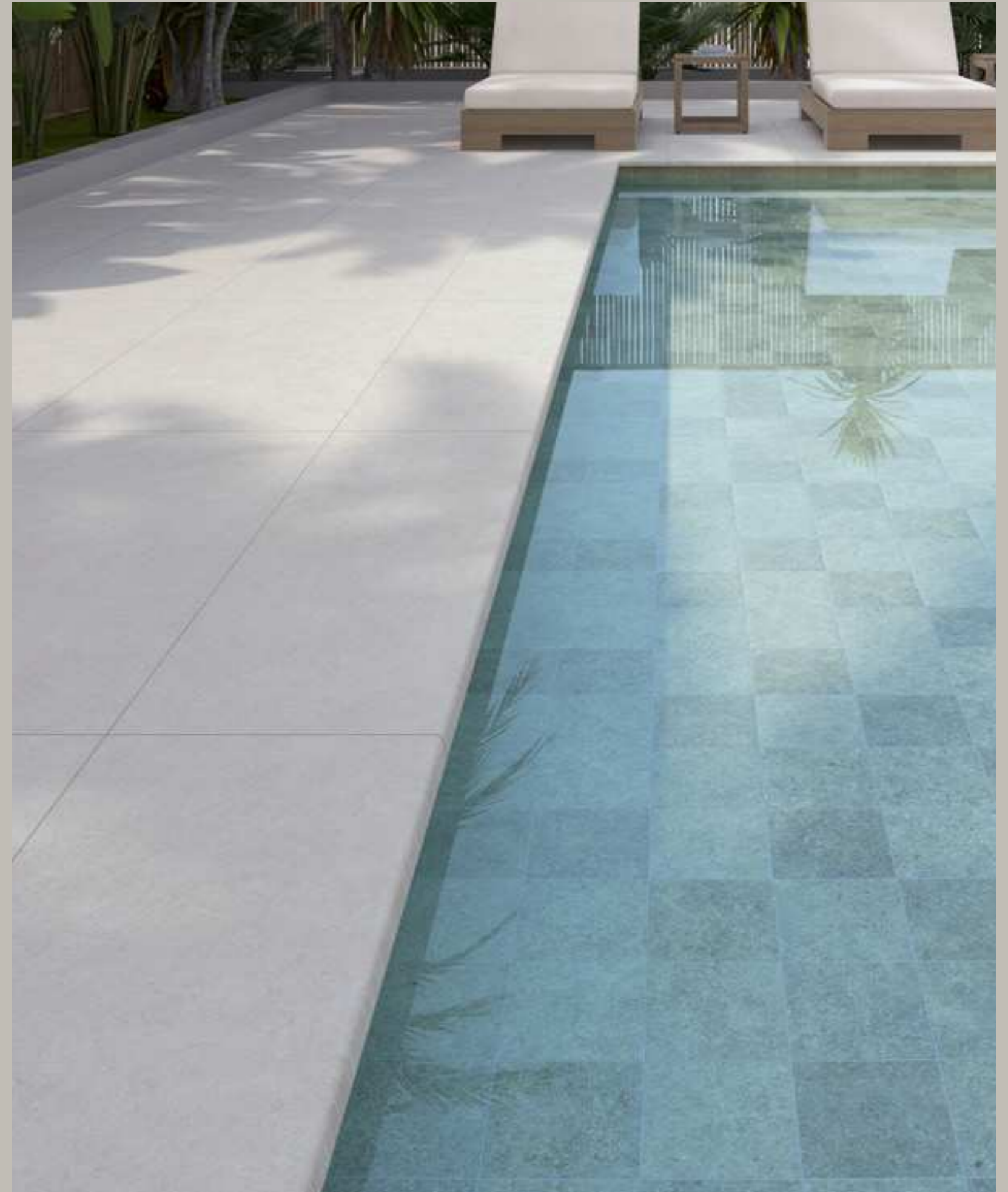

Pav. / Floor: Sarsen Stone White Antislip 60x120 - Peldaño Recto Sarsen Stone White Antislip 120x32/3 - Ángulo Peldaño Recto Int. Sarsen Stone White Antislip 120x32x45/3  
Vaso Piscina / Pool Basin: Sarsen Stone Turquoise Bali 15x15

# SARSEN STONE 20mm

PORCELÁNICO RECTIFICADO  
RECTIFIED PORCELAIN TILE

NEW  
2026

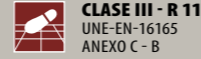

BORDES RECTIFICADOS - Rectified Edges

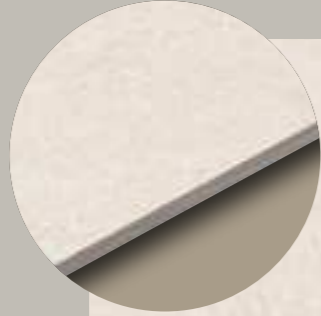
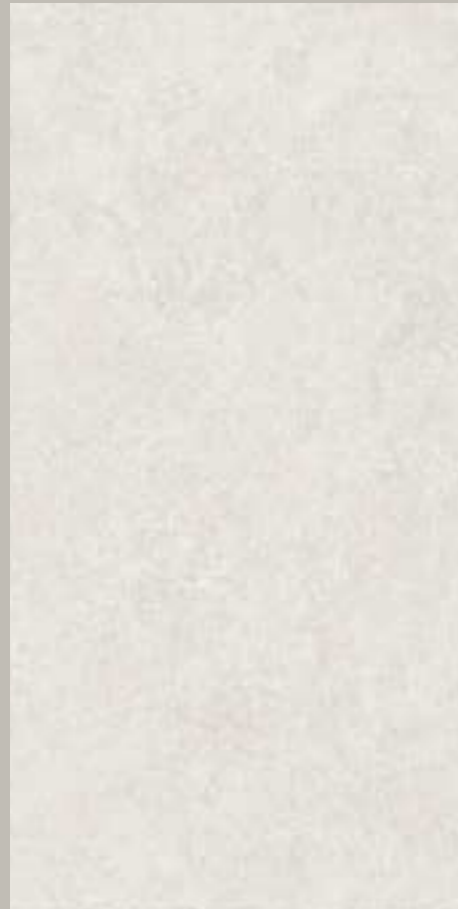

**SARSEN STONE WHITE ANTISLIP**  
60 x 120 x 2 (G 76) 24" x 48" x 1" **m²**  
20 mm.



**SARSEN STONE IVORY ANTISLIP**  
60 x 120 x 2 (G 76) 24" x 48" x 1" **m²**  
20 mm.

BORDES IRREGULARES - Irregular Edges

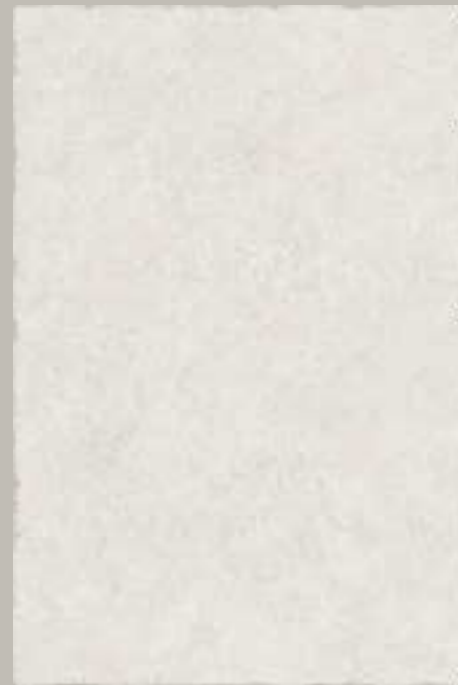

**SARSEN STONE WHITE ANTISLIP**  
60 x 90 x 2 (G 79) 24" x 36" x 1" **m²**  
20 mm.



**SARSEN STONE IVORY ANTISLIP**  
60 x 90 x 2 (G 79) 24" x 36" x 1" **m²**  
20 mm.



Colocación mínima recomendada de PLOTS para los formatos 60x120 Rec. y 60x90 con espesor de 20mm.  
Placement of the minimum recommended PLOTS 60x120 Rec. and 60x90 with a thickness of 20 mm.



Esquema de montaje con baldosas  
Mounting scheme with tiles

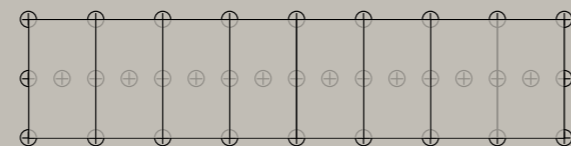

Pav. / Floor: Sarsen Stone Ivory Antislip 60x90 · Peldaño Recto Sarsen Stone Ivory Antislip 120x32/3 · Ángulo Peldaño Recto Int. / Ext. Sarsen Stone Ivory Antislip 120x32x45/3 · Frontal Sarsen Stone Ivory Antislip 15x120  
Vaso Piscina / Pool Basin: Sarsen Stone Turquoise Bali 15x15

# ORION

PORCELÁNICO RECTIFICADO  
RECTIFIED PORCELAIN TILE

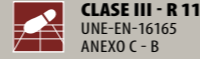

Pav. / Floor: Orion White Antislip 90x90 · Peldaño Recto Orion White Antislip 120x33/3  
Rev. / Wall: Orion White 90x90



Pav. / Floor: Orion Greige 90x90 · Peldaño Recto Orion Greige 120x33/3  
Rev. / Wall: Orion Greige 90x90



Pav. / Floor: Orion Graphite 90x90  
Rev. / Wall: Orion Graphite 90x90

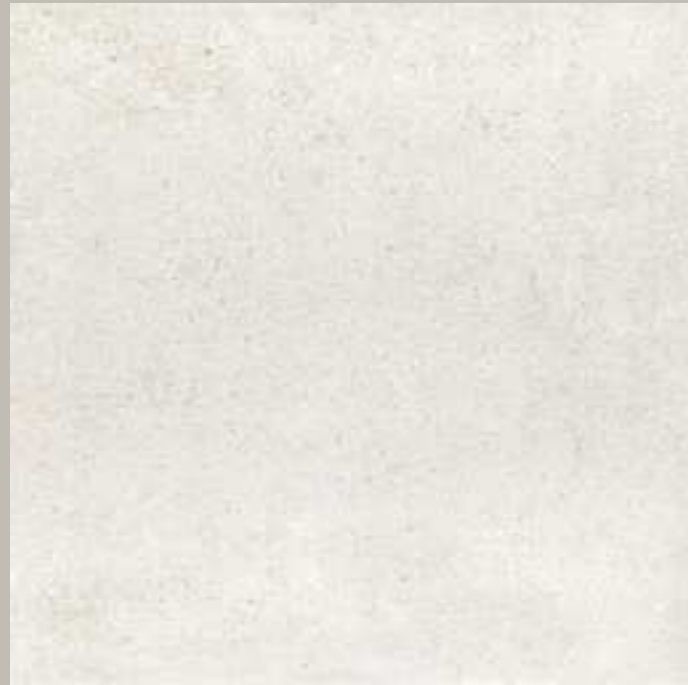

ORION WHITE 90 x 90 (G 79) 35,4" x 35,4" <sup>m²</sup>  
ORION WHITE 90 x 90 (G 80) ANTISLIP 35,4" x 35,4" <sup>m²</sup>  
± 9 mm.

10



ORION GREIGE 90 x 90 (G 79) 35,4" x 35,4" <sup>m²</sup>  
ORION GREIGE 90 x 90 (G 80) ANTISLIP 35,4" x 35,4" <sup>m²</sup>  
± 9 mm.

10

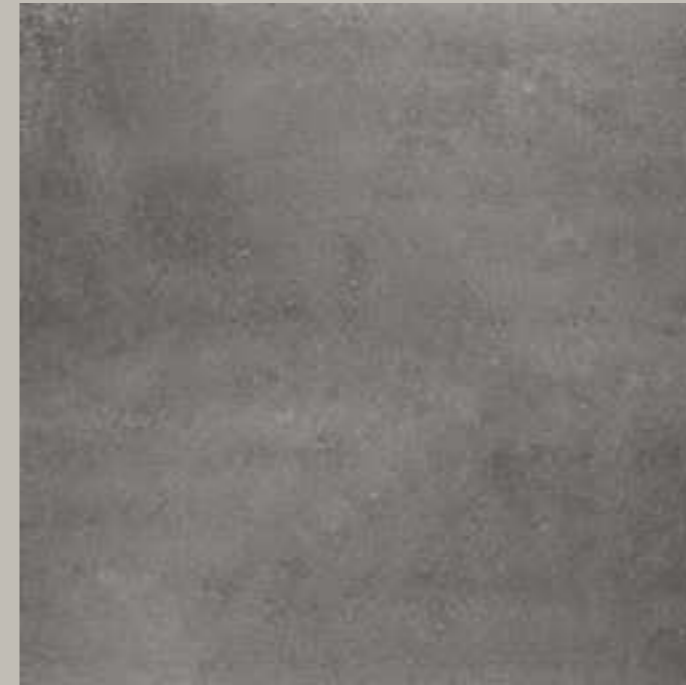

ORION GRAPHITE 90 x 90 (G 79) 35,4" x 35,4" <sup>m²</sup>  
± 9 mm.

10

PIEZAS ESPECIALES · SPECIAL PIECES  
Disponible en todos los colores · Available in all colors

**SPECIAL ORDER**  
BAJO PEDIDO

 <b>MEDIA CAÑA INT.</b> 4 x 30 x 4 (G 13) 1,5" x 11,8" x 1,5" ♦	 <b>COMP. INT. MEDIA CAÑA</b> 4 x 4 (G 17) 1,5" x 1,5" ♦	 <b>COMP. EXT. MEDIA CAÑA</b> 4 x 4 (G 17) 1,5" x 1,5" ♦
 <b>CUBRECANTO</b> 4 x 30 x 4 (G 15) 1,5" x 11,8" x 1,5" ♦	 <b>COMP. INT. CUBRECANTO</b> 4 x 4 (G 17) 1,5" x 1,5" ♦	 <b>COMP. EXT. CUBRECANTO</b> 4 x 4 (G 17) 1,5" x 1,5" ♦

EXTRUSIONADO PORCELÁNICO  
EXTRUDED PORCELAIN TILE

PIEZAS ESPECIALES · SPECIAL PIECES  
Disponible en WHITE y GREIGE · Available in WHITE & GREIGE

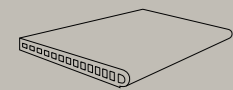

**BORDE PISCINA ANTISLIP**  
28 x 66,5/4 (G 80)  
10" x 26,5"/1,5" ♦

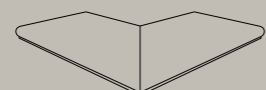

**ESQUINA EXT. BORDE PISCINA ANTISLIP**  
28 x 66,5 x 43/4 (G 56 x 2PZ)  
10" x 26,5" x 17"/1,5" ♦

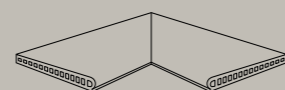

**ESQUINA INT. BORDE PISCINA ANTISLIP**  
28 x 66,5 x 43/4 (G 56 x 2PZ)  
10" x 26,5" x 17"/1,5" ♦

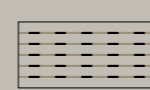

**GRATTING ANTISLIP**  
25 x 50/2,2 (G 78)  
10" x 20"/1" ♦

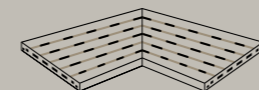

**ÁNGULO GRATTING ANTISLIP**  
25 x 50 x 35/2,2 (G 60 x 2PZ)  
10" x 20" x 15"/1" ♦

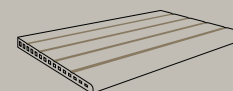

**DESBORDANTE ANTISLIP**  
30,5 x 50/2,4 (G 80)  
11,8" x 20"/1" ♦

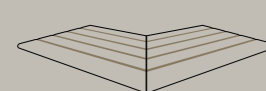

**ESQ. EXT. DESBORDANTE ANTISLIP**  
30,5 x 50 x 40/2,4 (G 56 x 2PZ)  
11,8" x 20" x 16"/1" ♦

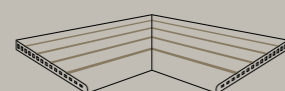

**ESQ. INT. DESBORDANTE ANTISLIP**  
30,5 x 50 x 40/2,4 (G 56 x 2PZ)  
11,8" x 20" x 16"/1" ♦



**GOMA PARA GRATTING**  
GRATTING RUBBER  
22,5 x 1,7 8,8" x 0,4"  
(SE NECESITAN 2 ud.  
POR GRATTING)



**SISTEMA GRATTING SIN IMPACTO**  
NON IMPACT GRATTING SYSTEM  
SYSTÈME DE GRATTEGE SANS IMPACT

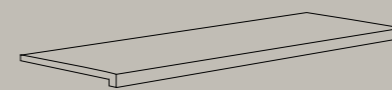
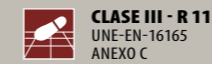

**PELDAÑO RECTO ANTISLIP**  
120 x 33/3 (G 72) 48" x 13"/1" ♦  
60 x 33/3 (G 73) 23,6" x 13"/1" ♦

**ÁNG. PELDAÑO RECTO INT. / EXT. ANTISLIP**  
120 x 33 x 45/3 (G 46 x 2)  
48" x 13" x 17,7"/1" ♦

EXTRUSIONADO PORCELÁNICO  
EXTRUDED PORCELAIN TILE

PIEZAS ESPECIALES · SPECIAL PIECES  
Disponible en todos los colores · Available in all colors

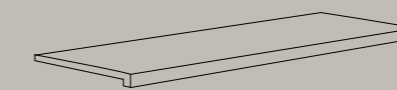

**PELDAÑO RECTO**  
120 x 33/3 (G 72) 48" x 13"/1" ♦  
60 x 33/3 (G 73) 23,6" x 13"/1" ♦

**ÁNG. PELDAÑO RECTO INT. / EXT.**  
120 x 33 x 45/3 (G 46 x 2)  
48" x 13" x 17,7"/1" ♦



**ÁNG. PELDAÑO RECTO**  
33 x 45/3 (G 18 x 2PZ)  
13" x 17,7"/1" ♦

**REMATE PELDAÑO RECTO - IZQ. / DRCH.**  
3 x 33 (G 15) 1" x 13" ♦

**ZÓCALO**  
8,5 x 90 (G 31)  
3,5" x 35,4" ♦

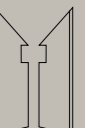

**ZANQUÍN RCT. IZQ. / DRCH.**  
8,5 x 30 (G 13)  
3,5" x 11,8" ♦



Pav. / Floor: **Alma Crema 90x90 - Alma Crema Antislip 90x90**  
Rev. / Wall: **Alma Crema 90x90**



Pav. / Floor: **Alma Marfil Antislip 90x90 - Peldaño Recto Alma Marfil Antislip 120x33/3 - Ángulo Peldaño Recto Int. Alma Marfil Antislip 120x33x45/3**  
Rev. / Wall: **Alma Marfil 90x90**



**ALMA CREMA 90 x 90 (G 79)** 35,4" x 35,4" **m²**  
**ALMA CREMA 90 x 90 (G 80) ANTISLIP** 35,4" x 35,4" **m²**  
⊗ 9,5 mm.

6

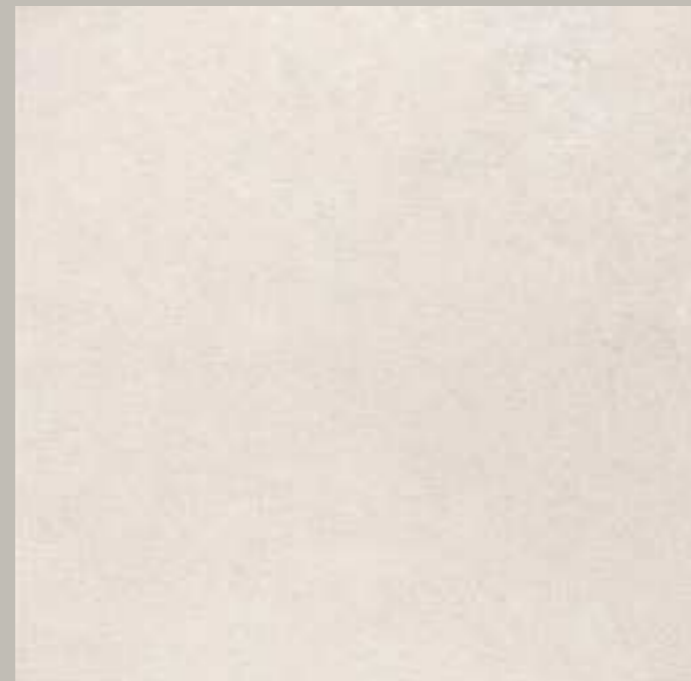

**ALMA MARFIL 90 x 90 (G 79)** 35,4" x 35,4" **m²**  
**ALMA MARFIL 90 x 90 (G 80) ANTISLIP** 35,4" x 35,4" **m²**  
⊗ 9,5 mm.

6

**EXTRUSIONADO PORCELÁNICO** · PIEZAS ESPECIALES · SPECIAL PIECES  
EXTRUDED PORCELAIN TILE



**PELDAÑO RECTO**  
**PELDAÑO RECTO ANTISLIP**  
120 x 33/3 (G 72) 48" x 13"/1" ♦  
60 x 33/3 (G 73) 23,6" x 13"/1" ♦

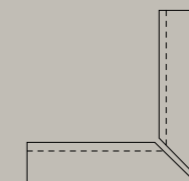

**ÁNG. PELDAÑO RECTO INT.**  
**ÁNG. PELDAÑO RECTO INT. ANTISLIP**  
120 x 33 x 45/3 (G 46 x 2)  
48" x 13" x 17,7"/1" ♦

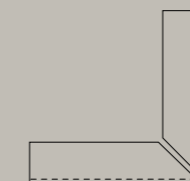

**ÁNG. PELDAÑO RECTO EXT.**  
**ÁNG. PELDAÑO RECTO EXT. ANTISLIP**  
120 x 33 x 45/3 (G 46 x 2)  
48" x 13" x 17,7"/1" ♦



**ÁNG. PELDAÑO RECTO**  
33 x 45/3 (G 18 x 2PZ)  
13" x 17,7"/1" ♦

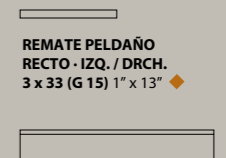

**REMATE PELDAÑO**  
**RECTO - IZQ. / DRCH.**  
3 x 33 (G 15) 1" x 13" ♦  
**ZÓCALO**  
8,5 x 90 (G 31)  
3,5" x 35,4" ♦

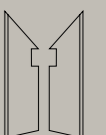

**ZANQUÍN REC.**  
**IZQ. / DRCH.**  
8,5 x 30 (G 13)  
3,5" x 11,8" ♦

# ANIMA

PORCELÁNICO RECTIFICADO  
RECTIFIED PORCELAIN TILE



CLASE I - R 9  
UNE-EN-16165  
ANEXO C - B



CLASE III - R 11  
UNE-EN-16165  
ANEXO C - B



CLASS C  
UNE-EN-16165  
ANEXO A



Pav. / Floor Anima Ceniza 90x90 - Peldaño Angular Anima Ceniza 120x32/3



Pav. / Floor: Anima Arena 90x90 - Peldaño Angular Anima Arena 120x32/3  
Remate Peldaño Ang. Anima Arena 3x32 - Zócalo Anima Arena 8,5x90 - Zanquín Ang. Anima Arena 8,5x30



Pav. / Floor Anima Luna Antislip 90x90 - Peldaño Angular Anima Luna Antislip 120x32/3 - Ángulo Peldaño Angular Int. Anima Luna Antislip 120x32x45/3 - Zanquín Angular Anima Luna 8,5x30



ANIMA CENIZA 90 x 90 (G 79) 35,4" x 35,4" m<sup>2</sup>  
ANIMA CENIZA 90 x 90 (G 80) ANTISLIP 35,4" x 35,4" m<sup>2</sup>  
x 9 mm.

12



ANIMA ARENA 90 x 90 (G 79) 35,4" x 35,4" m<sup>2</sup>  
ANIMA ARENA 90 x 90 (G 80) ANTISLIP 35,4" x 35,4" m<sup>2</sup>  
x 9 mm.

12



ANIMA LUNA 90 x 90 (G 79) 35,4" x 35,4" m<sup>2</sup>  
ANIMA LUNA 90 x 90 (G 80) ANTISLIP 35,4" x 35,4" m<sup>2</sup>  
x 9 mm.

12

## ESPECIFICACIONES TÉCNICAS CLASE I - R9 · TECHNICAL SPECIFICATIONS CLASE I - R9

RESISTE LA FLEXIÓN 51 N/mm <sup>2</sup>	RESISTE EL DESGASTE PEI (III - IV)	RESISTE EL RAYADO MOHS - 5	MANCHAS Clase 5 Clase A	ABSORCIÓN 0,1 %	CARGA DE ROTURA 3059 Nw

## ESPECIFICACIONES TÉCNICAS CLASE III - R11 · TECHNICAL SPECIFICATIONS CLASE III - R11

RESISTE LA FLEXIÓN 51 N/mm <sup>2</sup>	RESISTE EL DESGASTE PEI (III - IV)	RESISTE EL RAYADO MOHS - 6-9	MANCHAS Clase 5 Clase A	ABSORCIÓN 0,1 %	CARGA DE ROTURA 3059 Nw



## EXTRUSIONADO PORCELÁNICO · PIEZAS ESPECIALES · SPECIAL PIECES EXTRUDED PORCELAIN TILE

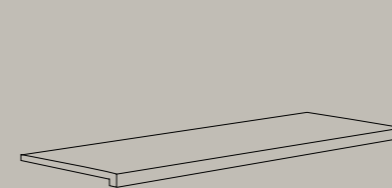

PELDAÑO ANGULAR  
PELDAÑO ANGULAR ANTISLIP  
120 x 32/3 (G 72) 48" x 12,5"/1" ♦  
60 x 32/3 (G 73) 23,6" x 12,5"/1" ♦

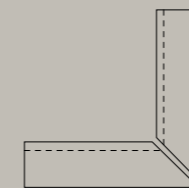

ÁNG. PELDAÑO ANG. INT.  
ÁNG. PELDAÑO ANG. INT. ANTISLIP  
120 x 32 x 45/3 (G 46 x 2)  
48" x 12,5" x 17,7"/1" ♦

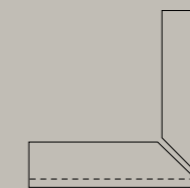

ÁNG. PELDAÑO ANG. EXT.  
ÁNG. PELDAÑO ANG. EXT. ANTISLIP  
120 x 32 x 45/3 (G 46 x 2)  
48" x 12,5" x 17,7"/1" ♦

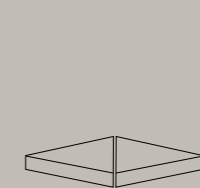

ÁNG. PELDAÑO ANG.  
32 x 45/3 (G 18 x 2PZ)  
12,5" x 17,7"/1" ♦

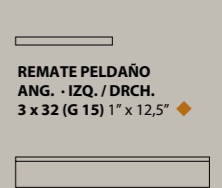

ZÓCALO  
8,5 x 90 (G 31)  
3,5" x 35,4" ♦



ZANQUÍN ANG.  
IZQ. / DRCH.  
8,5 x 30 (G 13)  
3,5" x 11,8" ♦

# ANIMA

EXTRUSIONADO PORCELÁNICO  
EXTRUDED PORCELAIN TILE

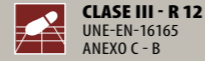

Pav. / Floor: Anima Ceniza Antislip 22,5x22,5 - Peldaño Angular Anima Ceniza Antislip 120x32/3



Pav. / Floor: Decor Anima Ceniza Antislip 22,5x22,5



Pav. / Floor: Anima Arena Antislip 22,5x22,5 - Decor Anima Arena Antislip 22,5x22,5 - Peldaño Angular Anima Arena Antislip 120x32/3



DECOR LINEAL ANTISLIP 22,5 x 22,5 (G 57) 8,8" x 8,8" 30  
x 10 mm.

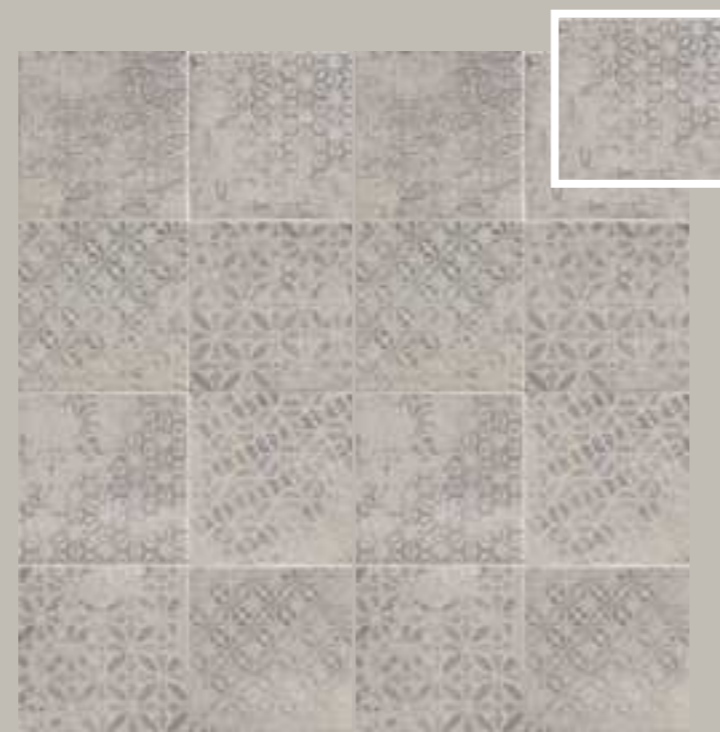

DECOR ANIMA CENIZA ANTISLIP 22,5 x 22,5 (G 57) 8,8" x 8,8" 30  
x 10 mm.



DECOR ANIMA ARENA ANTISLIP 22,5 x 22,5 (G 57) 8,8" x 8,8" 30  
x 10 mm.



ANIMA LUNA ANTISLIP  
22,5 x 22,5 (G 25)  
8,8" x 8,8"   
x 10 mm.



ANIMA ARENA ANTISLIP  
22,5 x 22,5 (G 25)  
8,8" x 8,8"   
x 10 mm.



ANIMA CENIZA ANTISLIP  
22,5 x 22,5 (G 25)  
8,8" x 8,8"   
x 10 mm.

## PIEZAS ESPECIALES - SPECIAL PIECES



PELDAÑO ANGULAR ANTISLIP  
120 x 32/3 (G 72) 48" x 12,5"/1"  
60 x 32/3 (G 73) 23,6" x 12,5"/1"



ÁNG. PELDAÑO ANG.  
ANTISLIP  
32 x 45/3 (G 18 x 2PZ)  
12,5" x 17,7"/1"

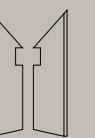

ZANQUÍN ANG.  
IZQ. / DRCH.  
8,5 x 30 (G 13)  
3,5" x 11,8"



ÁNG. PELDAÑO ANG. INT. / EXT. ANTISLIP  
120 x 32 x 45/3 (G 46 x 2)  
48" x 12,5" x 17,7"/1"

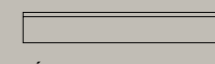

ZÓCALO  
8,5 x 60 (G 74)  
3,5" x 23,6"



REMATE PELDAÑO  
ANG. - IZQ. / DRCH.  
3 x 32 (G 15) 1" x 12,5"

# LIMESTONE

EXTRUSIONADO PORCELÁNICO  
EXTRUDED PORCELAIN TILE

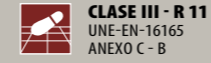

Pav. / Floor: Limestone White Antislip 60x60 - Peldaño Recto Limestone White Antislip 120x33/3



Pav. / Floor: Limestone Grey 60x60 - Limestone Grey 30x30  
Peldaño Recto Limestone Grey 120x33/3 - Zócalo Recto Limestone Grey 9x30  
Remate Peldaño Recto Limestone Grey 3x33



Pav. / Floor: Limestone Beige Antislip 60x60 - Limestone Beige Antislip 30x30



Rev. / Wall: Star Limestone Taupe 15,5x15,5 - Cross Limestone Taupe 15,5x15,5



LIMESTONE WHITE  
LIMESTONE WHITE ANTISLIP



LIMESTONE GREY  
LIMESTONE GREY ANTISLIP



LIMESTONE GREY  
LIMESTONE GREY ANTISLIP



LIMESTONE TAUPE  
LIMESTONE TAUPE ANTISLIP

## PIEZAS ESPECIALES - SPECIAL PIECES

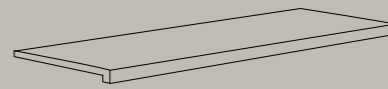

**PELDAÑO RECTO  
PELDAÑO RECTO ANTISLIP**  
120 x 33/3 (G 72) 48" x 13"/1"  
60 x 33/3 (G 73) 23,6" x 13"/1"

**REMATE PELDAÑO  
RECTO - IZQ. / DRCH.**  
3 x 33 (G 15) 1" x 13"

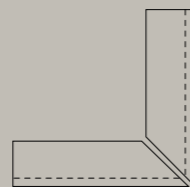

**ÁNG. PELDAÑO RECTO EXT.  
ÁNG. PELDAÑO RECTO EXT.  
ANTISLIP**  
120 x 32 x 45/3 (G 46 x 2)  
48" x 12,5" x 17,7"/1"

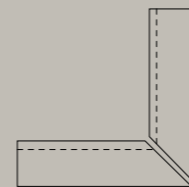

**ÁNG. PELDAÑO RECTO INT.  
ÁNG. PELDAÑO RECTO INT.  
ANTISLIP**  
120 x 32 x 45/3 (G 46 x 2)  
48" x 12,5" x 17,7"/1"

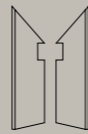

**ZANQUÍN RCT.  
IZQ. / DCHA.**  
9 x 30 (G 10)  
3,5" x 11,8"



**ÁNG. PELDAÑO RECTO  
ÁNG. PELDAÑO RECTO ANTISLIP**  
33 x 45/3 (G 18 x 2PZ)  
13" x 17,7"/1"



**VIERTEGUAS ANTISLIP**  
15 x 30/4 (G 12)  
5,9" x 11,8"/1,5"



**ZÓCALO**  
9 x 30 (G 06)  
3,5" x 11,8"

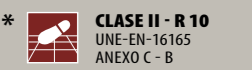
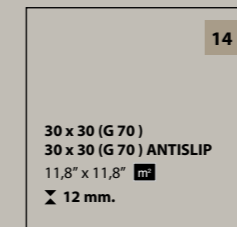
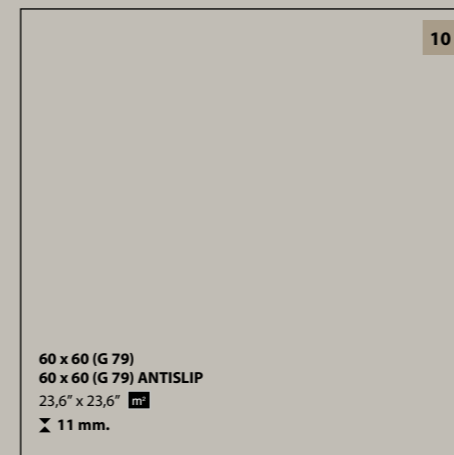

**STAR**  
15,5 x 15,5 (G 84)  
6" x 6"  $m^2$   
10 mm.

**CROSS**  
15,5 x 15,5 (G 84)  
6" x 6"  $m^2$   
10 mm.



Pav. / Floor: **Alpes Blanc 60x120**



Pav. / Floor: **Alpes Creme Antislip 60x120** - Desbordante **Alpes Creme Antislip 30,5x50/2,4**  
Esquina Int. Desbordante **Alpes Creme Antislip 30,5x50x40/2,4** - Grating **Alpes Creme Antislip 25x50/2,2**  
Ángulo Grating **Alpes Creme Antislip 25x50x35/2,2** - Peldaño Angular **Alpes Creme Antislip 120x32/3**  
Frontal **Alpes Creme 15x120** - Rev. / Wall: **Alpes Creme 60x120**



Rev. / Wall: **Alpes Pierre 60x120**  
Pav. / Floor: **Alpes Pierre 60x120** - Frontal **Alpes Pierre 15x120** - Peldaño Angular **Alpes Pierre 120x32/3**



**ALPES BLANC 60 x 120 (G 86)** 23,6" x 48" **10**  
**ALPES BLANC 60 x 120 (G 79) ANTISLIP** 23,6" x 48"   
✂ 9 mm.



**ALPES CREME 60 x 120 (G 86)** 23,6" x 48" **10**  
**ALPES CREME 60 x 120 (G 79) ANTISLIP** 23,6" x 48"   
✂ 9 mm.



**ALPES PIERRE 60 x 120 (G 86)** 23,6" x 48" **10**  
**ALPES PIERRE 60 x 120 (G 79) ANTISLIP** 23,6" x 48"   
✂ 9 mm.

**EXTRUSIONADO PORCELÁNICO**  
EXTRUDED PORCELAIN TILE

PIEZAS ESPECIALES · SPECIAL PIECES



**PELDAÑO ANGULAR**  
**PELDAÑO ANGULAR ANTISLIP**  
120 x 32/3 (G 72) 48" x 12,5"/1"   
60 x 32/3 (G 73) 23,6" x 12,5"/1"

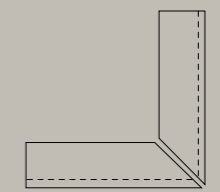
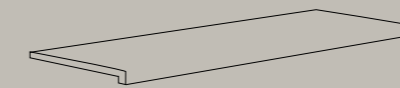

**ÁNG. PELDAÑO ANG. EXT.**  
**ÁNG. PELDAÑO ANG. EXT. ANTISLIP**  
120 x 32 x 45/3 (G 46 x 2)  
48" x 12,5" x 17,7"/1"

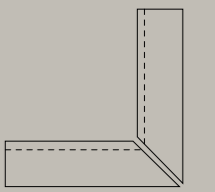

**ÁNG. PELDAÑO ANG. INT.**  
**ÁNG. PELDAÑO ANG. INT. ANTISLIP**  
120 x 32 x 45/3 (G 46 x 2)  
48" x 12,5" x 17,7"/1"

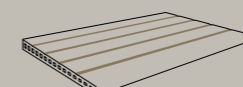

**DESBORDANTE ANTISLIP**  
30,5 x 50/2,4 (G 80)  
11,8" x 20"/1"

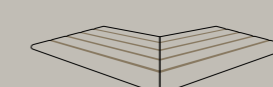

**ESQUINA EXT.**  
**DESBORDANTE ANTISLIP**  
30,5 x 50 x 40/2,4 (G 56 x 2PZ)  
11,8" x 20" x 16"/1"

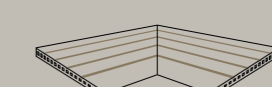

**ESQUINA INT.**  
**DESBORDANTE ANTISLIP**  
30,5 x 50 x 40/2,4 (G 56 x 2PZ)  
11,8" x 20" x 16"/1"

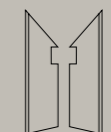

**ZANQUÍN ANG.**  
**IZQ. / DCHA.**  
9,8 x 30 (G 12)  
3,9" x 11,8"

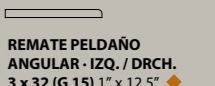

**REMATE PELDAÑO**  
**ANGULAR · IZQ. / DRCH.**  
3 x 32 (G 15) 1" x 12,5"

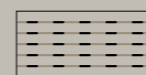

**GRATTING ANTISLIP**  
25 x 50/2,2 (G 78) 10" x 20"/1"

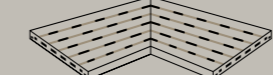

**ÁNG. GRATTING ANTISLIP**  
25 x 50 x 35/2,2 (G 60 x 2PZ)  
10" x 20" x 15"/1"



**SISTEMA GRATTING SIN IMPACTO**  
NON IMPACT GRATTING SYSTEM  
SYSTÈME DE GRATTEGE SANS IMPACT



**GOMA PARA GRATTING**  
GRATTING RUBBER 22,5 x 1,7 · 8,8" x 0,4"  
(SE NECESITAN 2 ud. POR GRATTING)

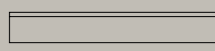

**ZÓCALO**  
9,8 x 120 (G 74) 3,9" x 48"   
9,8 x 60 (G 75) 3,9" x 23,6"



Pav. / Floor: Olimpo Grigio 60x120 · Peldaño Angular Olimpo Grigio 120x32/3 · Frontal Olimpo Grigio 15x120 · Remate Peldaño Ang. · Izq./Drch. Olimpo Grigio 3x32



Pav. / Floor: Olimpo Taupe 60x120  
Rev. / Wall: Olimpo Taupe 60x120



**OLIMPO GRIGIO 60 x 120 (G 86)** 23,6" x 48" **7**  
**OLIMPO GRIGIO 60 x 120 (G 79) ANTISLIP** 23,6" x 48"   
x 9 mm.



**OLIMPO CREMA 60 x 120 (G 86)** 23,6" x 48" **7**  
**OLIMPO CREMA 60 x 120 (G 79) ANTISLIP** 23,6" x 48"   
x 9 mm.



**OLIMPO TAUPE 60 x 120 (G 86)** 23,6" x 48" **7**  
**OLIMPO TAUPE 60 x 120 (G 79) ANTISLIP** 23,6" x 48"   
x 9 mm.

**EXTRUSIONADO PORCELÁNICO** PIEZAS ESPECIALES · SPECIAL PIECES  
EXTRUDED PORCELAIN TILE

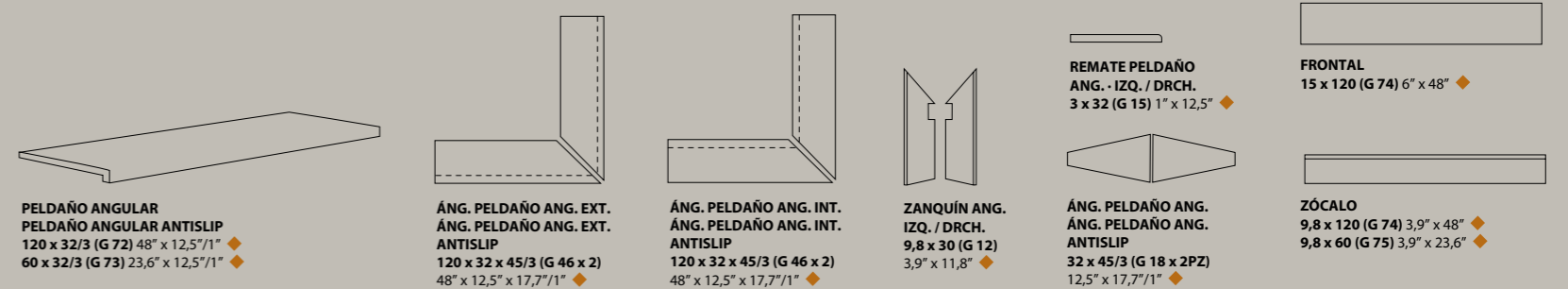

# POSETS

PORCELÁNICO RECTIFICADO  
RECTIFIED PORCELAIN TILE

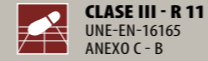

Pav. / Floor: Posets Blanco Antislip 60x120 · Peldaño Angular Posets Blanco Antislip 120x32/3 · Frontal Posets Blanco 15x120 · Ángulo Peldaño int. Posets Blanco Antislip 120x32x45/3



Pav. / Floor: Posets Beige 60x120 · Peldaño Angular Posets Beige 120x32/3 · Frontal Posets Beige 15x120 · Remate Peldaño Angular drch. Posets Beige 3x32  
Rev. / Wall: Posets Beige 60x120



POSETS BLANCO 60 x 120 (G 86) 23,6" x 48"  $\text{m}^2$  20  
POSETS BLANCO 60 x 120 (G 79) ANTISLIP 23,6" x 48"  $\text{m}^2$   
± 9 mm.



POSETS BEIGE 60 x 120 (G 86) 23,6" x 48"  $\text{m}^2$  20  
POSETS BEIGE 60 x 120 (G 79) ANTISLIP 23,6" x 48"  $\text{m}^2$   
± 9 mm.

EXTRUSIONADO PORCELÁNICO  
EXTRUDED PORCELAIN TILE

PIEZAS ESPECIALES · SPECIAL PIECES

- PELDAÑO ANGULAR  
PELDAÑO ANGULAR ANTISLIP**  
120 x 32/3 (G 72) 48" x 12,5"/1" ♦  
60 x 32/3 (G 73) 23,6" x 12,5"/1" ♦
- REMATE PELDAÑO  
ANGULAR · IZQ. / DRCH.**  
3 x 32 (G 15) 1" x 12,5" ♦
- ÁNG. PELDAÑO ANG. EXT.  
ÁNG. PELDAÑO ANG. EXT. ANTISLIP**  
120 x 32 x 45/3 (G 46 x 2)  
48" x 12,5" x 17,7"/1" ♦
- ÁNG. PELDAÑO ANG. INT.  
ÁNG. PELDAÑO ANG. INT. ANTISLIP**  
120 x 32 x 45/3 (G 46 x 2)  
48" x 12,5" x 17,7"/1" ♦
- ZÓCALO**  
9,8 x 120 (G 74) 3,9" x 48" ♦  
9,8 x 60 (G 75) 3,9" x 23,6" ♦
- FRONTAL**  
15 x 120 (G 74) 6" x 48" ♦
- BORDE PISCINA ANTISLIP**  
28 x 66,5/4 (G 80)  
10" x 26,5"/1,5" ♦
- ESQ. INT. BORDE PISCINA ANTISLIP**  
28 x 66,5 x 43/4 (G 56 x 2PZ)  
10" x 26,5" x 17"/1,5" ♦
- ESQ. EXT. BORDE PISCINA**  
28 x 66,5 x 43/4 (G 56 x 2PZ)  
10" x 26,5" x 17"/1,5" ♦
- ZANQUÍN ANG. · IZQ. / DRCH.**  
9,8 x 30 (G 12) 3,9" x 11,8" ♦
- ÁNG. PELDAÑO ANG.  
ÁNG. PELDAÑO ANG. ANTISLIP**  
32 x 45/3 (G 18 x 2PZ)  
12,5" x 17,7"/1" ♦

# POSETS ANTISLIP

EXTRUSIONADO PORCELÁNICO  
EXTRUDED PORCELAIN TILE

CLASE III - R 11  
UNE-EN-16165  
ANEXO C - B



Pav. / Floor: Posets Gris Antislip 36x72 · Borde Piscina Posets Gris Antislip 28x66,5/4 · Esquina Interior Borde Piscina Posets Gris Antislip 28x66,5x43/4 · Peldaño Angular Posets Gris Antislip 120x32/3



Pav. / Floor: Posets Beige Antislip 18x36 · Posets Beige Antislip 36x36 · Posets Beige Antislip 36x72 · Peldaño Angular Posets Beige Antislip 120x32/3 · Ángulo Peldaño Angular Posets Beige Antislip 120x32x45/3  
Rev. / Wall: Posets Beige 60x120

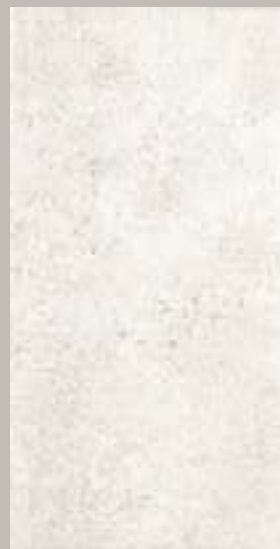

POSETS BLANCO ANTISLIP



POSETS DECO  
BLANCO ANTISLIP



POSETS GRIS ANTISLIP



POSETS DECO  
GRIS ANTISLIP



POSETS BEIGE ANTISLIP



POSETS DECO  
BEIGE ANTISLIP

## PIEZAS ESPECIALES · SPECIAL PIECES

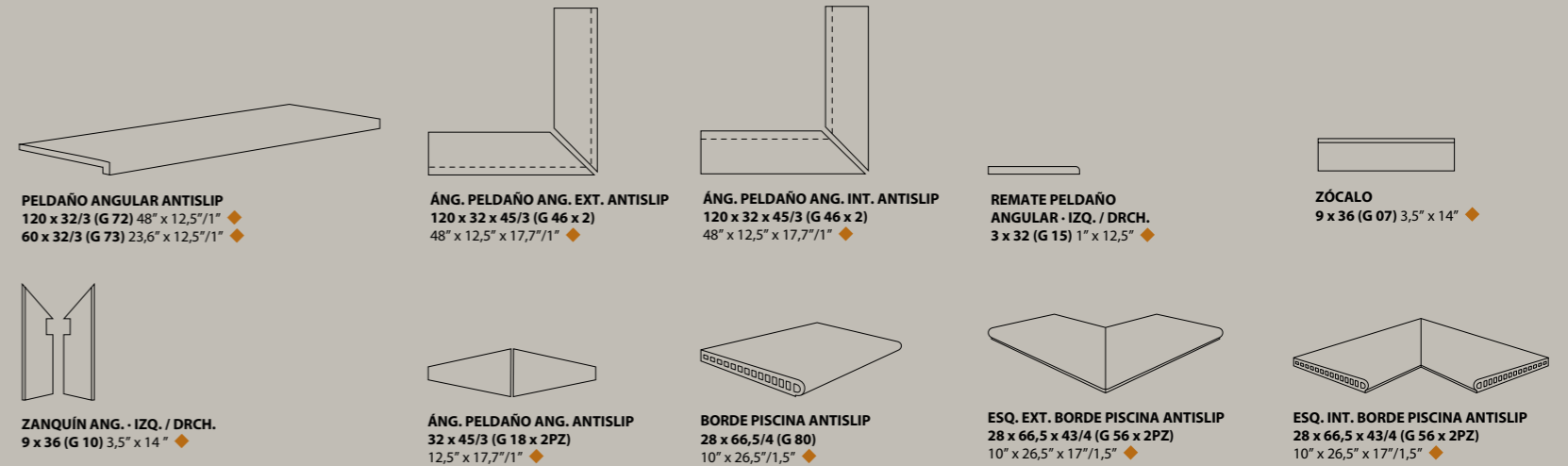

## IDEAS DE COLOCACIÓN 18 x 36 · 36 x 36 · 36 x 72 · INSTALLATIONS IDEAS 7" x 14" · 14" x 14" · 14" x 28"

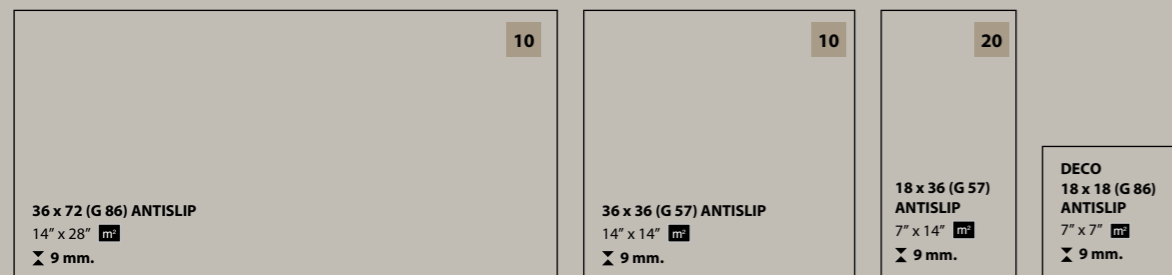
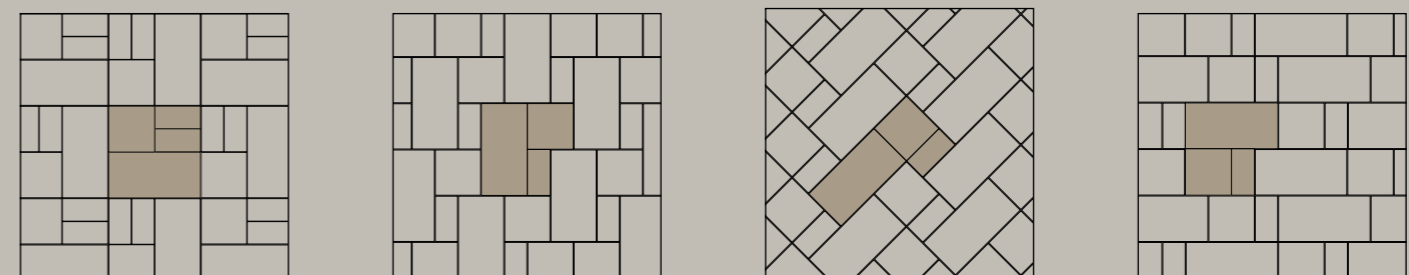

# PIEDRAS DEL BRUC

EXTRUSIONADO PORCELÁNICO  
EXTRUDED PORCELAIN TILE

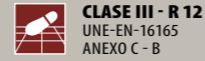

Pav. / Floor: Piedras del Bruc Gris Antislip 45x67,5 - Peldaño Angular Piedras del Bruc Gris Antislip 67,5x32/3 - Ángulo Peldaño int. Piedras del Bruc Gris Antislip 67,5x32x45/3



Pav. / Floor: Piedras del Bruc Beige Antislip 22,5x67,5 - Peldaño Angular Piedras del Bruc Beige Antislip 67,5x32/3



PIEDRAS DEL BRUC BLANCO  
PIEDRAS DEL BRUC BLANCO ANTISLIP



PIEDRAS DEL BRUC GRIS  
PIEDRAS DEL BRUC GRIS ANTISLIP



PIEDRAS DEL BRUC BEIGE  
PIEDRAS DEL BRUC BEIGE ANTISLIP

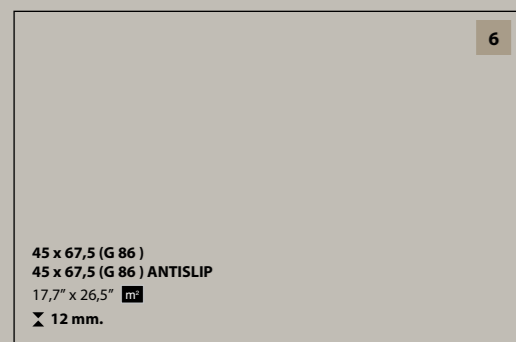

45 x 67,5 (G 86)  
45 x 67,5 (G 86) ANTISLIP  
17,7" x 26,5"  $m^2$   
12 mm.



22,5 x 67,5 (G 86) ANTISLIP  
8,8" x 26,5"  $m^2$   
12 mm.

## PIEZAS ESPECIALES · SPECIAL PIECES



PELDAÑO ANGULAR  
PELDAÑO ANGULAR ANTISLIP  
67,5 x 32/3 (G 80) 26,5" x 12,5"/1" ♦

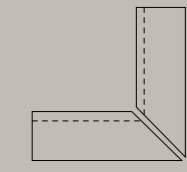

ÁNG. PELDAÑO ANG. INT.  
ÁNG. PELDAÑO ANG. INT. ANTISLIP  
67,5 x 32 x 45/3 (G 56 x 2)  
26,5" x 12,5" x 17,7"/1" ♦

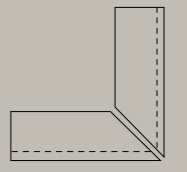

ÁNG. PELDAÑO ANG. EXT.  
ÁNG. PELDAÑO ANG. EXT. ANTISLIP  
67,5 x 32 x 45/3 (G 56 x 2)  
26,5" x 12,5" x 17,7"/1" ♦

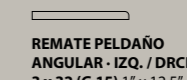

REMATE PELDAÑO  
ANGULAR · IZQ. / DRCH.  
3 x 32 (G 15) 1" x 12,5" ♦



ZÓCALO  
9 x 45 (G 10) 3,5" x 17,7" ♦

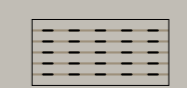
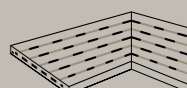

GRATTING ANTISLIP  
25 x 50/2,2 (G 78) 10" x 20"/1" ♦

ÁNG. GRATTING ANTISLIP  
25 x 50 x 35/2,2 (G 60 x 2PZ)  
10" x 20" x 15"/1" ♦

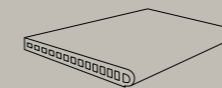

BORDE PISCINA ANTISLIP  
28 x 66,5/4 (G 80)  
10" x 26,5"/1,5" ♦

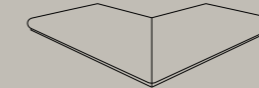

ESQ. EXT. BORDE PISCINA ANTISLIP  
28 x 66,5 x 43/4 (G 56 x 2PZ)  
10" x 26,5" x 17"/1,5" ♦

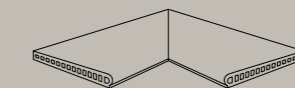

ESQ. INT. BORDE PISCINA ANTISLIP  
28 x 66,5 x 43/4 (G 56 x 2PZ)  
10" x 26,5" x 17"/1,5" ♦

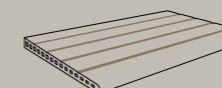

DESBORDANTE ANTISLIP  
30,5 x 50/2,4 (G 80)  
11,8" x 20"/1" ♦

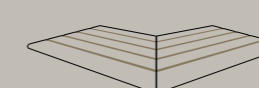

ESQ. EXT. DESBORDANTE ANTISLIP  
30,5 x 50 x 40/2,4 (G 56 x 2PZ)  
11,8" x 20" x 16"/1" ♦

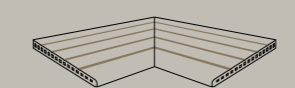

ESQ. INT. DESBORDANTE ANTISLIP  
30,5 x 50 x 40/2,4 (G 56 x 2PZ)  
11,8" x 20" x 16"/1" ♦



GOMA PARA GRATTING  
GRATTING RUBBER 22,5 x 1,7 - 8,8" x 0,4"  
(SE NECESITAN 2 ud. POR GRATTING)



SISTEMA GRATTING SIN IMPACTO  
NON IMPACT GRATTING SYSTEM  
SYSTÈME DE GRATTAGE SANS IMPACT

# PIRINEOS

PORCELÁNICO  
PORCELAIN TILE

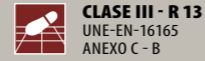

Pav. / Floor: Borde Piscina Pirineos Mix Antislip 28x66,5/4 - Esquina int. Borde Piscina Pirineos Mix Antislip 28x66,5x43/4 - Natur-Tech Central Park Antislip 20x90/2,6  
Vaso Piscina / Pool Basin: Pirineos Mix Antislip 15x15



Pav. / Floor: Pirineos Blanco Antislip 33x66,5 - Peldaño Angular Pirineos Blanco Antislip 66,5x32/3  
Vaso Piscina / Pool Basin: Pirineos Mix Antislip 15x15

MATE  
MATT  
PORCELÁNICO  
PORCELAIN TILE



**PIRINEOS BLANCO ANTISLIP** 33 x 66,5 (G 90) 13" x 26,5" 9 mm. 10  
**PIRINEOS BEIGE ANTISLIP** 33 x 66,5 (G 90) 13" x 26,5" 9 mm. 10  
**PIRINEOS GRIS ANTISLIP** 33 x 66,5 (G 90) 13" x 26,5" 9 mm. 10  
**PIRINEOS MIX ANTISLIP** 33 x 66,5 (G 90) 13" x 26,5" 9 mm. 10

MATE  
MATT  
EXTRUSIONADO PORCELÁNICO  
EXTRUDED PORCELAIN TILE

BRILLO  
GLOSS  
EXTRUSIONADO PORCELÁNICO  
EXTRUDED PORCELAIN TILE



**PIRINEOS MIX ANTISLIP** \*15 x 15 (G 79) 6" x 6" 9 mm. CLASE III - R13 10  
**PIRINEOS MIX** \*15 x 15 (G 79) 6" x 6" 9 mm. CLASE I - R9 10

EXTRUSIONADO PORCELÁNICO  
EXTRUDED PORCELAIN TILE

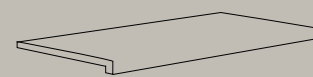

**PELDAÑO ANGULAR**  
**PELDAÑO ANGULAR ANTISLIP**  
66,5 x 32/3 (G 80) 26,5" x 12,5"/1" 10



**ÁNG. PELDAÑO ANG.**  
**ÁNG. PELDAÑO ANG. ANTISLIP**  
66,5 x 32 x 45/3 (G 56 x 2PZ)  
26,5" x 12,5" x 17,7"/1" 10

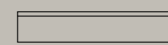

**ZÓCALO**  
9,8 x 66,5 (G 75) 3,9" x 26,5" 10

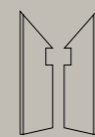

**ZANQUÍN ANG. - IZQ. / DRCH.**  
9,8 x 30 (G 12) 3,9" x 11,8" 10



**BORDE PISCINA ANTISLIP**  
28 x 66,5/4 (G 80) 10" x 26,5"/1,5" 10



**ESQ. INT. BORDE PISCINA ANTISLIP**  
28 x 66,5 x 43/4 (G 56 x 2PZ)  
10" x 26,5" x 17,7"/1,5" 10



**ESQ. EXT. BORDE PISCINA ANTISLIP**  
28 x 66,5 x 43/4 (G 56 x 2PZ)  
10" x 26,5" x 17,7"/1,5" 10



Pav. / Floor: Tech Geo Volcano Antislip 11x22,5 · Tech Geo Volcano Antislip 22,5x22,5 · Tech Geo Volcano Antislip 22,5x33 · Peldaño Curvo Tech Geo Volcano Antislip 22,5x33/4



Pav. / Floor: Tech Geo Mountain Antislip 11x22,5 · Tech Geo Mountain Antislip 22,5x33



Pav. / Floor: Tech Geo Glacier Antislip 11x22,5 · Tech Geo Glacier Antislip 22,5x22,5



TECH GEO GLACIER ANTISLIP



TECH GEO MOUNTAIN ANTISLIP



TECH GEO RIVER ANTISLIP



TECH GEO VOLCANO ANTISLIP



TECH GEO GLACIER 22,5 x 33 · 8,8" x 13"  
TECH GEO GLACIER 22,5 x 22,5 · 8,8" x 8,8"  
TECH GEO GLACIER 11 x 22,5 · 4,3" x 8,8"



TECH GEO RIVER 22,5 x 22,5 · 8,8" x 8,8"  
TECH GEO RIVER 11 x 22,5 · 4,3" x 8,8"



TECH GEO MOUNTAIN 22,5 x 33 · 8,8" x 13"  
TECH GEO MOUNTAIN 22,5 x 22,5 · 8,8" x 8,8"  
TECH GEO MOUNTAIN 11 x 22,5 · 4,3" x 8,8"



TECH GEO VOLCANO 22,5 x 22,5 · 8,8" x 8,8"  
TECH GEO VOLCANO 11 x 22,5 · 4,3" x 8,8"

16  
22,5 x 33 (G 58) ANTISLIP  
8,8" x 13"  
14 mm.

16  
22,5 x 22,5 (G 58) ANTISLIP  
8,8" x 8,8"  
14 mm.

32  
11 x 22,5 (G 39) ANTISLIP  
4,3" x 8,8"  
14 mm.

ESPECIFICACIONES TÉCNICAS · TECHNICAL SPECIFICATIONS

RESISTE LA FLEXIÓN 32 N/mm<sup>2</sup> RESISTE EL DESGASTE PEI (II-IV) RESISTE EL RAYADO MOHS - 8-9 MANCHAS Clase 5 - Clase A ABSORCIÓN 0,1% DILATACIÓN 6,6" 10" / °C CARGA DE ROTURA 3546 Nw

PIEZAS ESPECIALES · SPECIAL PIECES

PELDAÑO CURVO ANTISLIP  
22,5 x 33/4 (G 16) 8,8" x 13"/1,5"

ÁNG. PELD. CURVO 4PZ. ANTISLIP  
33 x 33/4 (G 58 x juego) 13" x 13"/1,5"

ÁNG. PELD. CURVO ANTISLIP  
33 x 46/4 (G 19 x 2PZ) 13" x 18"/1,5"

ZÓCALO  
9 x 30 (G 06) 3,5" x 11,8"

ZANQUÍN CV. - IZQ. / DCHA.  
9 x 30 (G 10) 3,5" x 11,8"

# NATURX 2.0 TRANSIT

EXTRUSIONADO PORCELÁNICO  
EXTRUDED PORCELAIN TILE

CLASE III - R 12  
UNE-EN-16165  
ANEXO C - B

≥60  
DCOF

CLASS C  
UNE-EN-16165  
ANEXO A

20 mm  
ESPESOR  
THICKNESS



Pav. / Floor: Transit Frost 2.0 Antislip 20x30 · Canaleta Con Desagüe Transit Frost 2.0 15x20x2  
Zócalo Transit Frost 2.0 9x30



Pav. / Floor: Transit P. Mix 2.0 Antislip 20x20 · Transit P. Mix 2.0 Antislip 20x30



Pav. / Floor: Transit B. East 2.0 Antislip 20x20 · Zócalo Angular Transit B. East 2.0 6x30x4 · Peldaño Curvo Transit B. East Antislip 2.0 36x33/4 · Canaleta Transit B. East 2.0 15x20/2 · Canaleta Con Desagüe Transit B. East 2.0 15x20x2  
Rev. / Wall: Transit B. East 2.0 Antislip 20x20



TRANSIT TOBACCO 2.0 ANTISLIP

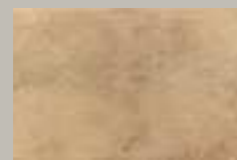

TRANSIT B. EAST 2.0 ANTISLIP

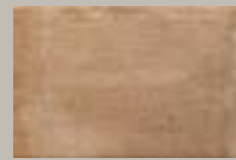

TRANSIT B. NORTH 2.0 ANTISLIP

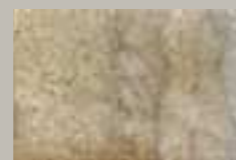

TRANSIT P. MIX 2.0 ANTISLIP



TRANSIT FROST 2.0 ANTISLIP



TRANSIT CLOUD 2.0 ANTISLIP

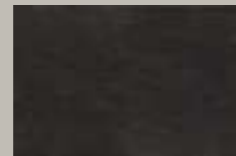

TRANSIT DARK 2.0 ANTISLIP

## ESPECIFICACIONES TÉCNICAS · TECHNICAL SPECIFICATIONS

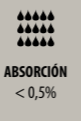

## PAVIMENTO DE ALTO RENDIMIENTO · HIGH PERFORMANCE FLOOR TILE

APLICACIONES · APPLICATIONS



\* NO apto para usar sobre PLOTS  
\* NOT suitable for use on PLOTS



ÁREAS RESIDENCIALES  
RESIDENTIAL AREAS



ZONAS URBANAS  
URBAN AREAS



TERRAZAS Y PATIOS  
TERRACE & PATIOS



ZONAS COMERCIALES  
COMMERCIAL AREAS



ZONAS DE ALTO TRÁNSITO  
HIGH TRAFFIC AREAS



PISCINAS  
SWIMMING POOLS



JARDINES  
GARDENS



ÁREAS INDUSTRIALES  
INDUSTRIAL AREAS



ZONAS DE ALTAS  
EXIGENCIAS HIGIÉNICAS  
HIGH AREAS  
HYGIENIC REQUIREMENTS

# NATUR 2.0 TRANSIT

EXTRUSIONADO PORCELÁNICO  
EXTRUDED PORCELAIN TILE

**CLASE III - R 12**  
UNE-EN-16165  
ANEXO C - B

**≥60**  
DCOF

**CLASS C**  
UNE-EN-16165  
ANEXO A

**20 mm**  
ESPESOR  
THICKNESS

**PE** **SPECIAL ORDER**  
BAJO PEDIDO



Pav. / Floor: **Transit Tobacco 2.0 Antislip 20x20** · **Transit Tobacco 2.0 Antislip 20x30**



Pav. / Floor: **Transit B. North 2.0 Antislip 20x20** · **Transit B. North 2.0 Antislip 20x30** · **Zócalo Transit B. North 9x36**  
**Stop Transit Frost 2.0 20x20** · **Go Transit Frost 2.0 20x20** · **Peldaño Curvo Transit B. North Antislip 36x33/4**  
Rev. / Wall: **Boston Brick Downtown Trab. Enm 25x50**



Pav. / Floor: **Transit Cloud 2.0 Antislip 20x30** · **Stop Transit Dark 2.0 20x20 3** · **Go Transit Dark 2.0 20x20** · **Peldaño Angular Transit Cloud 2.0 Antislip 66,5x32/3**

Disponibles en FROST, CLOUD y DARK  
Available in FROST, CLOUD and DARK

**Piezas Especiales Podotáctiles**  
Special podotactile pieces

Disponibles en todos los colores  
Available in all colors



**STOP**  
20 x 20 (G 91) 8" x 8"

**GO**  
20 x 20 (G 91) 8" x 8"



**CANALETA ANTISLIP**  
15 x 20/2 (G 92) 5,9" x 8"/1"

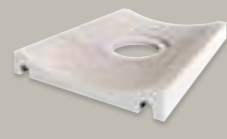

**CANALETA CON DESAGÜE ANTISLIP**  
15 x 20/2 (G 38) 5,9" x 8"/1"



ABSORCIÓN  
<0,5%



CLASE 5 - CLASE A  
Resistente a las manchas  
Stain resistant



A/LA/R/A  
Resistencia química  
Chemical resistance

Disponibles en B. EAST y B. NORTH  
Available in B. EAST and B. NORTH



**PELDAÑO CURVO ANTISLIP**  
22,5 x 33/4 (G 16) 8,8" x 13"/1,5"  
36 x 33/4 (G 18) 14" x 13"/1,5"



**ÁNG. PELD. CURVO ANTISLIP**  
33 x 46/4 (G 19 x 2PZ)  
13" x 18"/1,5"



**ZANQUÍN CV. IZQ. / DRCH.**  
9 x 36 (G 10) 3,5" x 14"



**VIERTEAGUAS ANTISLIP**  
15 x 22,5/4 (G 10)  
5,9" x 8,8"/1,5"



**ZÓCALO**  
9 x 36 (G 07) 3,5" x 14"

Disponibles en FROST, CLOUD, TOBACCO, P. MIX y DARK  
Available in FROST, CLOUD, TOBACCO, P. MIX and DARK



**PELDAÑO ANG. ANTISLIP**  
66,5 x 32/3 (G 80)  
26,5" x 12,5"/1"



**ÁNG. PELDAÑO ANG. ANTISLIP**  
66,5 x 32 x 45/3 (G 56 x 2PZ)  
26,5" x 12,5" x 17,7"/1"

Disponibles en FROST, CLOUD, TOBACCO y DARK  
Available in FROST, CLOUD, TOBACCO and DARK



**ZANQUÍN ANG. IZQ. / DRCH.**  
9 x 30 (G 10) 3,5" x 11,8"

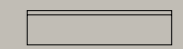

**ZÓCALO**  
9 x 30 (G 06) 3,5" x 11,8"

Disponibles en FROST, B. EAST y P. MIX  
Available in FROST, B. EAST and P. MIX



**ZÓCALO ANGULAR**  
6 x 30 x 4 (G 74)  
2,5" x 11,8" x 1,5"

**MEDIA CAÑA INT.**  
4 x 30 x 4 (G 13)  
1,5" x 11,8" x 1,5"

**CUBRECANTO**  
4 x 30 x 4 (G 15)  
1,5" x 11,8" x 1,5"

**COMP. EXT. MEDIA CAÑA**  
4 x 4 (G 17)  
1,5" x 1,5"

**COMP. INT. MEDIA CAÑA**  
4 x 4 (G 17)  
1,5" x 1,5"

**COMP. INT. CUBRECANTO**  
4 x 4 (G 17)  
1,5" x 1,5"

**COMP. EXT. CUBRECANTO**  
4 x 4 (G 17)  
1,5" x 1,5"

**COMP. EXT. ZÓCALO ANG.**  
6 x 4 (G 85)  
2,5" x 1,5"

**COMP. INT. ZÓCALO ANG.**  
6 x 4 (G 85)  
2,5" x 1,5"

Disponibles en P. MIX  
Available in P. MIX



**ZÓCALO**  
9,8 x 66,5 (G 75)  
3,9" x 26,5"



**ZANQUÍN ANG. IZQ. / DRCH.**  
9,8 x 30 (G 12) 3,9" x 11,8"

# NATUR-TECH

PAVIMENTO DRENANTE DE EXTERIOR

EXTRUSIONADO PORCELÁNICO  
EXTRUDED PORCELAIN TILE

CLASE III - R 11  
UNE-EN-16165  
ANEXO C - B

26 mm  
ESPESOR  
THICKNESS



Pav. / Floor: Natur-Tech Piedras del Bruc Blanco Antislip 20x90/2,6  
Remate Triángulo Natur-Tech Piedras del Bruc Blanco Antislip 20x6,5/2,6



Pav. / Floor: Natur-Tech Natura Sand Antislip 20x90/2,6  
Remate Triángulo Natur-Tech Natura Sand Antislip 20x6,5/2,6  
Rev. / Wall: Natur-Tech Natura Sand Antislip 20x90/2,6



Pav. / Floor: Natur-Tech Natura Camel Antislip 20x90/2,6 - Peldaño Angular Natura Camel Antislip 120x32/3 - Ángulo Peldaño Int. Natura Camel Antislip 120x32x45/3

## PIEZAS ESPECIALES · SPECIAL PIECES



REMATE ANGULAR NATUR-TECH ANTISLIP  
20 x 90/2,6 (G 90) 8" x 35,4"/1"  
20 x 45/2,6 (G 17) 8" x 17,7"/1"



REMATE TRIÁNGULO NATURTECH ANTISLIP  
20 x 6,5/2,6 (G 16) 8" x 2,5"/1"

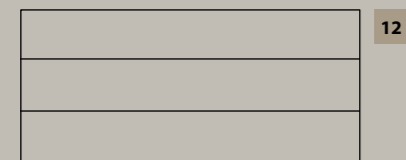

20 x 45/2,6 (G 84) ANTISLIP 8" x 17,7"/1" m<sup>2</sup>  
26 mm.



20 x 90/2,6 (G 89) ANTISLIP 8" x 35,4"/1" m<sup>2</sup>  
26 mm.

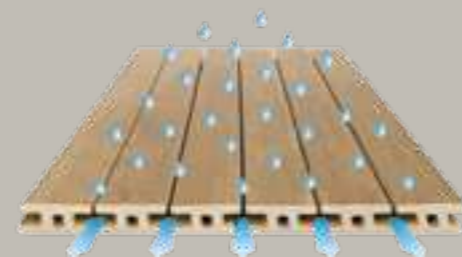

PAVIMENTO DRENANTE DE EXTERIOR  
OUTDOOR DRAINING EXTRUDED FLOOR

## NATUR-TECH



GUÍA DE COLOCACIÓN  
INSTALLATION GUIDE

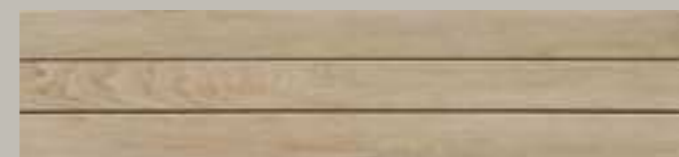

NATUR-TECH NATURA SAND ANTISLIP



NATUR-TECH NATURA CAMEL ANTISLIP



NATUR-TECH HYDE PARK ANTISLIP

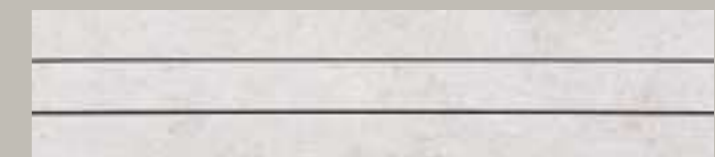

NATUR-TECH PIEDRAS DEL BRUC BLANCO ANTISLIP

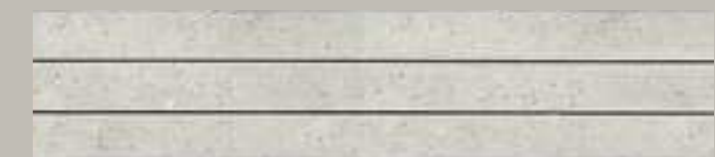

NATUR-TECH PIEDRAS DEL BRUC GRIS ANTISLIP



NATUR-TECH CENTRAL PARK ANTISLIP



Sherwood Nut 20 x 120

**SHERWOOD, la fuerza natural de la madera.**  
*SHERWOOD, the natural strength of wood.*



**SHERWOOD**



NATUCER  
*cerámica natural*

NEW  
2026

# SHERWOOD

La serie SHERWOOD nace de la esencia más pura de la naturaleza. Sus texturas y tonalidades evocan la calidez de los bosques, aportando carácter, autenticidad y armonía a cualquier espacio. Una colección pensada para crear ambientes acogedores con un diseño atemporal y sofisticado.

The SHERWOOD series is born from the purest essence of nature. Its textures and tones evoke the warmth of forests, bringing character, authenticity, and harmony to any space. A collection designed to create welcoming environments with a timeless and sophisticated design.

NATUCER  
*cerámica natural*



Pav. / Floor: Sherwood Nut 25x150 · Peldaño Recto Sherwood Nut 150x33/3 · Remate Recto Izq. Sherwood Nut 3x33  
Rev. / Wall: Boston Brick South 6,5x25



Pav. / Floor: Sherwood Linde 25x150 - Peldaño Recto Sherwood Linde 120x33/3 - Frontal Sherwood Linde 15x120 - Remate Sherwood Linde Izq. / Dech. 3x33

**14**

20 x 120 (G 68)  
20 x 120 (G 70) ANTISLIP  
8"x 48"  $m^2$   
± 9 mm.

**14**

25 x 150 (G 79)  
25 x 150 (G 80) ANTISLIP  
10"x 60"  $m^2$   
± 10 mm.



Pav. / Floor: Sherwood Birch 20x120 - Sherwood Birch Antislip 20x120 - Zócalo Sherwood Birch 9,8x120



**SHERWOOD LINDE**  
20 x 120 (G 68) 8"x 48"  $m^2$   
25 x 150 (G 79) 10"x 60"  $m^2$

**SHERWOOD LINDE ANTISLIP**  
20 x 120 (G 70) 8"x 48"  $m^2$



**SHERWOOD BIRCH**  
20 x 120 (G 68) 8"x 48"  $m^2$   
25 x 150 (G 79) 10"x 60"  $m^2$

**SHERWOOD BIRCH ANTISLIP**  
20 x 120 (G 70) 8"x 48"  $m^2$   
25 x 150 (G 80) 10"x 60"  $m^2$



**SHERWOOD OAK**  
20 x 120 (G 68) 8"x 48"  $m^2$   
25 x 150 (G 79) 10"x 60"  $m^2$

**SHERWOOD OAK ANTISLIP**  
20 x 120 (G 70) 8"x 48"  $m^2$   
25 x 150 (G 80) 10"x 60"  $m^2$



**SHERWOOD NUT**  
20 x 120 (G 68) 8"x 48"  $m^2$   
25 x 150 (G 79) 10"x 60"  $m^2$

**SHERWOOD NUT ANTISLIP**  
20 x 120 (G 70) 8"x 48"  $m^2$

**EXTRUSIONADO PORCELÁNICO**  
EXTRUDED PORCELAIN TILE



**PIEZAS ESPECIALES - SPECIAL PIECES**  
Disponible en todos los colores - Available in all colors

**CLASE I - R 9**  
UNE-EN-16165  
ANEXO C - B

**CLASE III - R 11**  
UNE-EN-16165  
ANEXO C - B

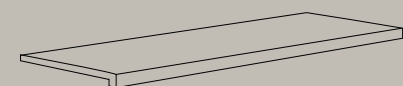

**PELDAÑO RECTO**  
120 x 33/3 (G 72) 48" x 13"/1" ♦  
60 x 33/3 (G 73) 23,6" x 13"/1" ♦  
150 x 33/3 (G 81) 60" x 13"/1" ♦



**PELDAÑO RECTO ANTISLIP**  
120 x 33/3 (G 72) 48" x 13"/1" ♦  
60 x 33/3 (G 73) 23,6" x 13"/1" ♦

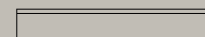

**ZÓCALO**  
9,8 x 120 (G 74) 3,9" x 48" ♦  
9,8 x 60 (G 75) 3,9" x 23,6" ♦



**REMATE PELDAÑO RECTO IZQ. / DRCH.**  
3 x 33 (G 15) 1" x 13" ♦

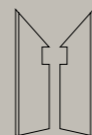

**ZANQUÍN RECTO IZQ. / DRCH.**  
9,8 x 30 (G 13) 4" x 11,8" ♦

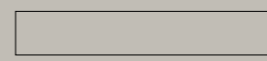

**FRONTAL**  
15 x 120 (G 36) 6" x 48" ♦



**PIEZAS ESPECIALES - SPECIAL PIECES**  
Disponible en OAK y BIRCH - Available in OAK & BIRCH

**CLASE I - R 9**  
UNE-EN-16165  
ANEXO C - B

**CLASE III - R 11**  
UNE-EN-16165  
ANEXO C - B



**PELDAÑO BLOCK**  
PELDAÑO BLOCK ANTISLIP  
120 x 33/1,4 (G 79) 48" x 13"/0,5" ♦

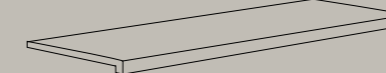

**PELDAÑO RECTO**  
PELDAÑO RECTO ANTISLIP  
150 x 33/3 (G 81) 60" x 13"/1" ♦

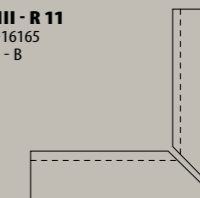

**ÁNG. PELDAÑO RECTO INT.**  
ÁNG. PELDAÑO RECTO INT. ANTISLIP  
150 x 33 x 45/3 (G 46 x 2)  
60" x 13" x 17,7"/1" ♦

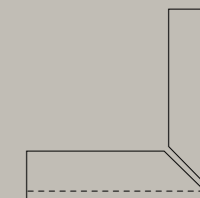

**ÁNG. PELDAÑO RECTO EXT.**  
ÁNG. PELDAÑO RECTO EXT. ANTISLIP  
150 x 33 x 45/3 (G 46 x 2)  
60" x 13" x 17,7"/1" ♦

# SHERWOOD 30x180

PORCELÁNICO RECTIFICADO  
RECTIFIED PORCELAIN TILE

NEW  
2026

CLASE I - R 9  
UNE-EN-16165  
ANEXO C - B



Pav. / Floor: Sherwood Birch 25x150 · Sherwood Birch 20x120 · Sherwood Birch 30x180 · Peldaño Recto Sherwood Birch 120x33/3 · Frontal Sherwood Birch 15x120 · Remate Sherwood Birch 3x33  
Rev. / Wall: Sarsen Stone Greige 60x120



Pav. / Floor: Sherwood Oak Antislip 20x120 · Peldaño Recto Sherwood Oak Antislip 120x33/3 · Frontal Sherwood Oak 15x120

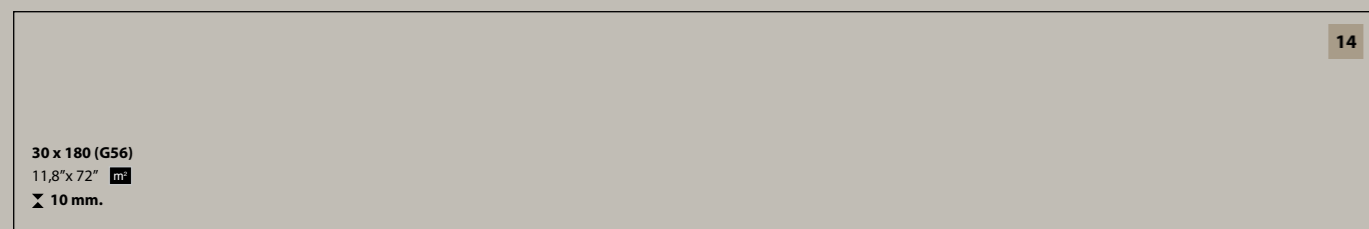

SHERWOOD OAK

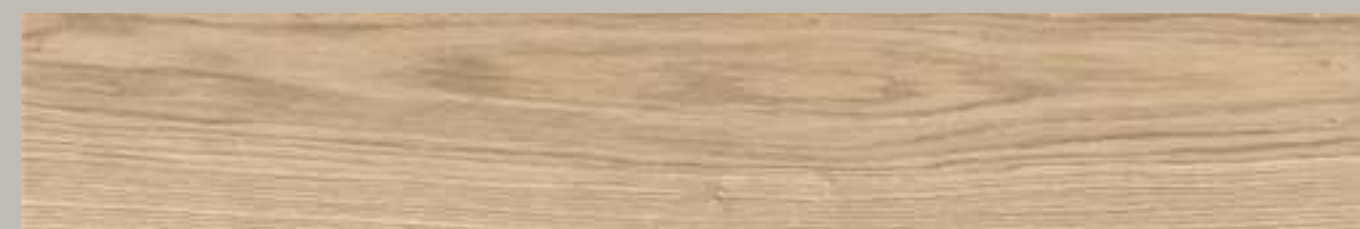

SHERWOOD BIRCH

EXTRUSIONADO PORCELÁNICO  
EXTRUDED PORCELAIN TILE



PIEZAS ESPECIALES · SPECIAL PIECES  
Disponible en OAK y BIRCH · Available in OAK & BIRCH

CLASE I - R 9  
UNE-EN-16165  
ANEXO C - B

CLASE III - R 11  
UNE-EN-16165  
ANEXO C - B



PELDAÑO BLOCK  
PELDAÑO BLOCK ANTISLIP  
120 x 33/1,4 (G 79) 48" x 13"/0,5"



PELDAÑO RECTO  
PELDAÑO RECTO ANTISLIP  
150 x 33/3 (G 81) 60" x 13"/1"  
120 x 33/3 (G 72) 48" x 13"/1"  
60 x 33/3 (G 73) 23,6" x 13"/1"

ÁNG. PELDAÑO RECTO INT. / EXT.  
ÁNG. PELDAÑO RECTO INT. / EXT. ANTISLIP  
120 x 33 x 45/3 (G 46 x 2) 48" x 13" x 17,7"/1"  
150 x 33 x 45/3 (G 46 x 2) 60" x 13" x 17,7"/1"



ZÓCALO  
9,8 x 120 (G 74) 3,9" x 48"  
9,8 x 60 (G 75) 3,9" x 23,6"



REMATE PELDAÑO RECTO IZQ. / DRCH.  
3 x 33 (G 15) 1" x 13"

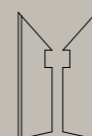

ZANQUÍN RCT. IZQ. / DRCH.  
9,8 x 30 (G 13) 4" x 11,8"

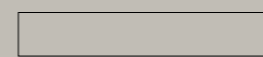

FRONTAL  
15 x 120 (G 36) 6" x 48"



Pav. / Floor: Zermatt Honey Antislip 25x150 - Peldaño Recto Zermatt Honey Antislip 120x33/3  
Ángulo Peldaño Recto Int. Zermatt Honey Antislip 120x33/3



Pav. / Floor: Zermatt Natural 25x150



Pav. / Floor: Zermatt Walnut 25x150

18

25 x 150 (G 79)  
25 x 150 (G 80) ANTISLIP  
10" x 60"   
Δ 10 mm.



ZERMATT HONEY  
ZERMATT HONEY ANTISLIP



ZERMATT NATURAL  
ZERMATT NATURAL ANTISLIP



ZERMATT WALNUT  
ZERMATT WALNUT ANTISLIP

EXTRUSIONADO PORCELÁNICO  
EXTRUDED PORCELAIN TILE

PIEZAS ESPECIALES · SPECIAL PIECES

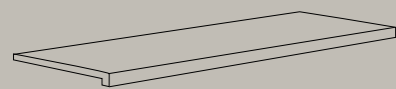

**PELDAÑO RECTO**  
**PELDAÑO RECTO ANTISLIP**  
150 x 33/3 (G 81) 60" x 13 7/16" ♦  
120 x 33/3 (G 72) 48" x 13 7/16" ♦  
60 x 33/3 (G 73) 23,6" x 13 7/16" ♦

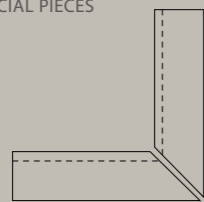

**ÁNG. PELDAÑO RECTO INT.**  
**ÁNG. PELDAÑO RECTO INT. ANTISLIP**  
120 x 33 x 45/3 (G 46 x 2) 48" x 13" x 17,7 1/16" ♦  
150 x 33 x 45/3 (G 51 x 2) 60" x 13" x 17,7 1/16" ♦

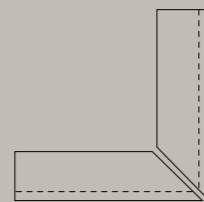

**ÁNG. PELDAÑO RECTO EXT.**  
**ÁNG. PELDAÑO RECTO EXT. ANTISLIP**  
120 x 33 x 45/3 (G 46 x 2) 48" x 13" x 17,7 1/16" ♦  
150 x 33 x 45/3 (G 51 x 2) 60" x 13" x 17,7 1/16" ♦



**ZANQUÍN RCT. - IZQ. / DRCH.**  
9,8 x 30 (G 13) 4" x 11,8" ♦



**ÁNG. PELDAÑO RECTO**  
**ÁNG. PELDAÑO RECTO ANTISLIP**  
33 x 45/3 (G 18 x 2PZ)  
13" x 17,7 1/16" ♦

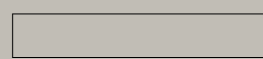

**FRONTAL**  
15 x 120 (G 36) 6" x 48" ♦



**REMATE PELDAÑO**  
**RECTO - IZQ. / DRCH.**  
3 x 33 (G 15) 1" x 13" ♦

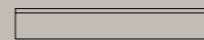

**ZÓCALO**  
9,8 x 75 (G 17) 4" x 30" ♦

# BOTANICA

PORCELÁNICO RECTIFICADO  
RECTIFIED PORCELAIN TILE

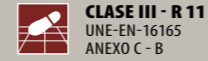

Pav. / Floor: Botánica Grey Antislip 25x150 - Peldaño Angular Botánica Grey Antislip 120x32/3 - Frontal Botánica Grey 15x120



Pav. / Floor: Botánica Alamo 25x150 - Peldaño Angular Botánica Alamo 120x32/3 - Frontal Botánica Alamo 15x120 - Zócalo Botánica Alamo 9,8x120 - Zanquín Angular Izq. / Drch. Botánica Alamo 9,8x30

\* **18**

25 x 150 (G 79)  
25 x 150 (G 80) ANTISLIP  
10" x 60"   
x 10 mm.

\* **CLASE I - R 9**  
UNE-EN-16165  
ANEXO C - B

\* Colores ABEDUL y MAPLE  
solo disponibles en CLASE I - R9  
\* ABEDUL & MAPLE colors  
only available in CLASE I - R9

EXTRUSIONADO PORCELÁNICO  
EXTRUDED PORCELAIN TILE

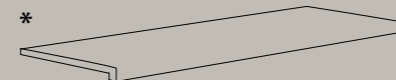

PELDAÑO ANGULAR  
PELDAÑO ANGULAR ANTISLIP  
120 x 32/3 (G 72) 48" x 12,5"/1" ♦  
60 x 32/3 (G 73) 23,6" x 12,5"/1" ♦

REMATE PELDAÑO  
ANGULAR · IZQ. / DRCH.  
3 x 32 (G 15) 1" x 12,5" ♦



FRONTAL  
15 x 120 (G 74) 6" x 48" ♦

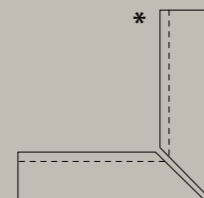

ÁNG. PELDAÑO ANG. INT.  
ÁNG. PELDAÑO ANG. INT.  
ANTISLIP  
120 x 32 x 45/3 (G 46 x 2)  
48" x 12,5" x 17,7"/1" ♦



ÁNG. PELDAÑO ANG. EXT.  
ÁNG. PELDAÑO ANG. EXT.  
ANTISLIP  
120 x 32 x 45/3 (G 46 x 2)  
48" x 12,5" x 17,7"/1" ♦



ZÓCALO  
9,8 x 75 (G 74) 3,9" x 30" ♦



ZANQUÍN ANG. · IZQ. / DRCH.  
9,8 x 30 (G 12) 4" x 11,8" ♦



BOTANICA GREY  
BOTANICA GREY ANTISLIP



BOTANICA ALAMO  
BOTANICA ALAMO ANTISLIP



BOTANICA ABEDUL



BOTANICA MAPLE

# NATURA 25x150

PORCELÁNICO RECTIFICADO  
RECTIFIED PORCELAIN TILE

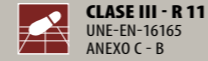

Pav. / Floor: Natura Sand 25x150 - Peldaño Angular Natura Sand 120x32/3 - Frontal Natura Sand 15x120



Pav. / Floor: Natura Camel 25x150  
Rev. / Wall: Lineage Ivory 6,5x20

**18**

25 x 150 (G 79)  
25 x 150 (G 80) ANTISLIP  
10" x 60" mm  
± 10 mm.

EXTRUSIONADO PORCELÁNICO  
EXTRUDED PORCELAIN TILE

PIEZAS ESPECIALES · SPECIAL PIECES

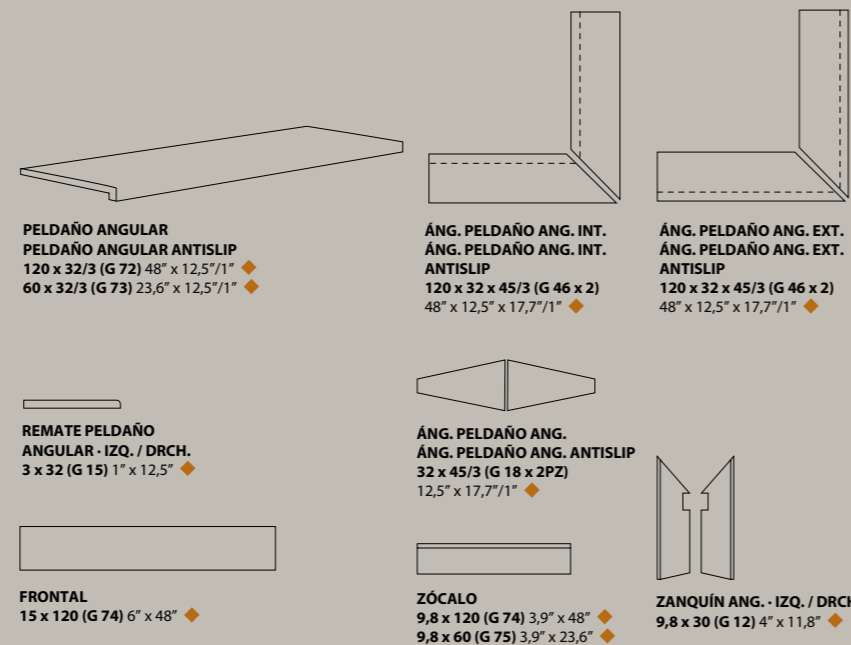

NATURA SAND  
NATURA SAND ANTISLIP



NATURA CAMEL  
NATURA CAMEL ANTISLIP

# NATURA

PORCELÁNICO RECTIFICADO  
RECTIFIED PORCELAIN TILE

**CLASE I - R 9**  
UNE-EN-16165  
ANEXO C - B

**CLASE III - R 11**  
UNE-EN-16165  
ANEXO C - B

**CLASS B**  
UNE-EN-16165  
ANEXO A

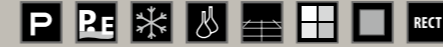

Pav. / Floor: **Natura Sand 20x120** - Peldaño Angular **Natura Sand 120x32/3** - Remate Peldaño Angular Izq. / Drch. **Natura Sand 3x32** - Frontal **Natura Sand 15x120**



Pav. / Floor: **Natura Camel 20x120** - Peldaño Angular **Natura Camel 120x32/3** - Remate Peldaño Angular Izq. / Drch. **Natura Camel 3x32**



Pav. / Floor: **Natura Umber 20x120** - Peldaño Angular **Natura Umber 60x32/3** - Zanquín Angular **Natura Umber 9,8x30** - Zócalo **Natura Umber 9,8x60**

\* **20 x 120 (G 68)**  
**20 x 120 (G 70) ANTISLIP**  
8" x 48" **in<sup>2</sup>**  
9 mm.

18

\* **CLASE I - R 9**  
UNE-EN-16165  
ANEXO C - B

\* Colores **UMBER** y **WHITE** solo disponibles en CLASE I - R 9  
\* **UMBER** & **WHITE** colors only available in CLASE I - R 9

## ESPECIFICACIONES TÉCNICAS · TECHNICAL SPECIFICATIONS

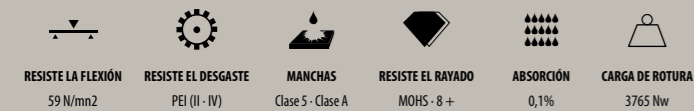

**EXTRUSIONADO PORCELÁNICO**  
EXTRUDED PORCELAIN TILE

PIEZAS ESPECIALES · SPECIAL PIECES

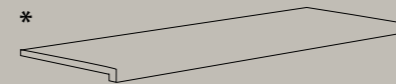

\* **PELDAÑO ANGULAR**  
**PELDAÑO ANGULAR ANTISLIP**  
120 x 32/3 (G 72) 48" x 12,5"/1"   
60 x 32/3 (G 73) 23,6" x 12,5"/1"

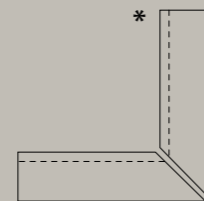

\* **ÁNG. PELDAÑO ANG. INT.**  
**ÁNG. PELDAÑO ANG. INT.**  
**ANTISLIP**  
120 x 32 x 45/3 (G 46 x 2)  
48" x 12,5" x 17,7"/1"

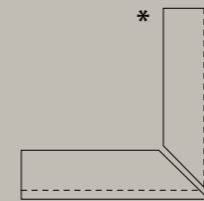

\* **ÁNG. PELDAÑO ANG. EXT.**  
**ÁNG. PELDAÑO ANG. EXT.**  
**ANTISLIP**  
120 x 32 x 45/3 (G 46 x 2)  
48" x 12,5" x 17,7"/1"

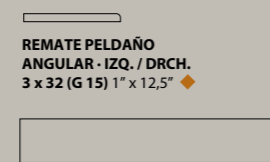

\* **REMATE PELDAÑO**  
**ANGULAR · IZQ. / DRCH.**  
3 x 32 (G 15) 1" x 12,5"

\* **FRONTAL**  
15 x 120 (G 74) 6" x 48"



\* **ÁNG. PELDAÑO ANG.**  
**ÁNG. PELDAÑO ANG. ANTISLIP**  
32 x 45/3 (G 18 x 2PZ)  
12,5" x 17,7"/1"



\* **ZÓCALO**  
9,8 x 120 (G 74) 3,9" x 48"   
9,8 x 60 (G 75) 3,9" x 23,6"

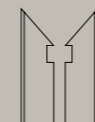

\* **ZANQUÍN ANG. · IZQ. / DRCH.**  
9,8 x 30 (G 12) 4" x 11,8"



NATURA SAND



NATURA CAMEL  
NATURA CAMEL ANTISLIP



NATURA UMBER



NATURA WHITE  
NATURA WHITE ANTISLIP



Pav. / Floor: Alquézar Arena 20x120 · Alquézar Arena Antislip 20x120 · Peldaño Angular Alquézar Arena Antislip 120x32/3 · Frontal Alquézar Arena 15x120 · Zócalo Alquézar Arena 9,8x60



Pav. / Floor: Alquézar Tabaco 20x120 · Peldaño Angular Alquézar Tabaco 120x32/3 · Remate Peldaño Angular Izq. Alquézar Tabaco 3x32 Frontal Alquézar Tabaco 15x120 · Zanquín Angular Alquézar Tabaco 9,8x30 · Zócalo Alquézar Tabaco 9,8x60

\* **20 x 120 (G 68)**  
**20 x 120 (G 70) ANTISLIP**  
8" x 48" **9**  
9 mm.

\* **CLASE I - R 9**  
UNE-EN-16165  
ANEXO C - B  
\* Color MIEL solo disponibles en CLASE I - R9  
\* MIEL colors only available in CLASE I - R9

ESPECIFICACIONES TÉCNICAS · TECHNICAL SPECIFICATIONS

RESISTE LA FLEXIÓN 59 N/mn2	RESISTE EL DESGASTE PEI (II - IV)	MANCHAS Clase 5 - Clase A	RESISTE EL RAYADO MOHS - 7	ABSORCIÓN 0,1%	CARGA DE ROTURA 3765 Nw

EXTRUSIONADO PORCELÁNICO · EXTRUDED PORCELAIN TILE  
PIEZAS ESPECIALES · SPECIAL PIECES



<b>PELDAÑO ANGULAR</b> <b>PELDAÑO ANGULAR ANTISLIP</b> 120 x 32/3 (G 72) 48" x 12,5"/1" ♦ 60 x 32/3 (G 73) 23,6" x 12,5"/1" ♦	<b>ÁNG. PELDAÑO ANG. INT.</b> <b>ÁNG. PELDAÑO ANG. INT. ANTISLIP</b> 120 x 32 x 45/3 (G 46 x 2) 48" x 12,5" x 17,7"/1" ♦	<b>ÁNG. PELDAÑO ANG. EXT.</b> <b>ÁNG. PELDAÑO ANG. EXT. ANTISLIP</b> 120 x 32 x 45/3 (G 46 x 2) 48" x 12,5" x 17,7"/1" ♦
<b>REMATE PELDAÑO ANGULAR - IZQ. / DRCH.</b> 3 x 32 (G 15) 1" x 12,5" ♦	<b>ÁNG. PELDAÑO ANG. ANTISLIP</b> 32 x 45/3 (G 18 x 2PZ) 12,5" x 17,7"/1" ♦	
<b>FRONTAL</b> 15 x 120 (G 74) 6" x 48" ♦	<b>ZÓCALO</b> 9,8 x 120 (G 74) 3,9" x 48" ♦ 9,8 x 60 (G 75) 3,9" x 23,6" ♦	<b>ZANQUÍN ANG. - IZQ. / DRCH.</b> 9,8 x 30 (G 12) 4" x 11,8" ♦



ALQUÉZAR TABACO  
ALQUÉZAR TABACO ANTISLIP



ALQUÉZAR MIEL



ALQUÉZAR ARENA  
ALQUÉZAR ARENA ANTISLIP



Pav. / Floor: Stanley Park 20x120 · Peldaño Angular Stanley Park 120x32/3 · Frontal Stanley Park 15x120



Rev. / Wall: Hyde Park 20x120 · Convex Calç 5x25  
Pav. / Floor: Hyde Park 20x120



Pav. / Floor: Retiro Park 20x120

20 x 120 (G 68)  
20 x 120 (G 70) ANTISLIP  
8" x 48"   
x 9 mm.

18

\* **CLASE I - R 9**  
UNE-EN-16165  
ANEXO C - B

\* Colores RETIRO PARK y STANLEY PARK solo disponibles en CLASE I - R9  
\* RETIRO PARK & STANLEY PARK colors only available in CLASE I - R9

ESPECIFICACIONES TÉCNICAS · TECHNICAL SPECIFICATIONS

RESISTE LA FLEXIÓN 59 N/mm <sup>2</sup>	RESISTE EL DESGASTE PEI (II - IV)	MANCHAS Clase 5 - Clase A	RESISTE EL RAYADO MOHS-7	ABSORCIÓN 0,1%	CARGA DE ROTURA 3765 Nw

EXTRUSIONADO PORCELÁNICO  
EXTRUDED PORCELAIN TILE

PIEZAS ESPECIALES · SPECIAL PIECES

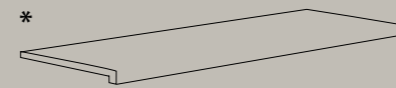

\* **PELDAÑO ANGULAR**  
**PELDAÑO ANGULAR ANTISLIP**  
120 x 32/3 (G 72) 48" x 12,5"/1" ♦  
60 x 32/3 (G 73) 23,6" x 12,5"/1" ♦

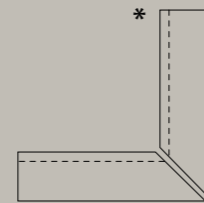

\* **ÁNG. PELDAÑO ANG. INT.**  
**ÁNG. PELDAÑO ANG. INT.**  
**ANTISLIP**  
120 x 32 x 45/3 (G 46 x 2)  
48" x 12,5" x 17,7"/1" ♦

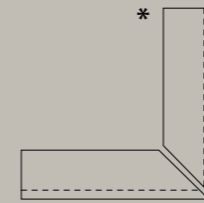

\* **ÁNG. PELDAÑO ANG. EXT.**  
**ÁNG. PELDAÑO ANG. EXT.**  
**ANTISLIP**  
120 x 32 x 45/3 (G 46 x 2)  
48" x 12,5" x 17,7"/1" ♦

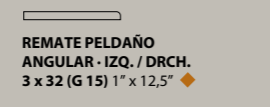

\* **REMATE PELDAÑO**  
**ANGULAR · IZQ. / DRCH.**  
3 x 32 (G 15) 1" x 12,5" ♦

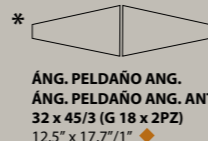

\* **ÁNG. PELDAÑO ANG.**  
**ÁNG. PELDAÑO ANG. ANTISLIP**  
32 x 45/3 (G 18 x 2PZ)  
12,5" x 17,7"/1" ♦

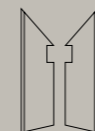

\* **ZÓCALO**  
9,8 x 120 (G 74) 3,9" x 48" ♦  
9,8 x 60 (G 75) 3,9" x 23,6" ♦

\* **FRONTAL**  
15 x 120 (G 74) 6" x 48" ♦

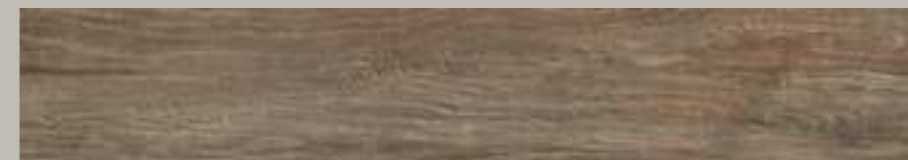

RETIRO PARK



HYDE PARK  
HYDE PARK ANTISLIP



STANLEY PARK



CENTRAL PARK  
CENTRAL PARK ANTISLIP

# RETRO

EXTRUSIONADO PORCELÁNICO  
EXTRUDED PORCELAIN TILE

CLASE III - R 11  
UNE-EN-16165  
ANEXO C - B



Pav. / Floor: **Retro Blanc Antislip 21x60** · **Retro Blanc Antislip 7x60**  
**Peldaño Angular Retro Blanc Antislip 32x32/4**



Rev. / Wall: **Retro Blanc Antislip 7x60**  
Pav. / Floor: **Retro Blanc Hex Antislip 36x41,5**



Pav. / Floor: **Retro Negro Antislip 21x60**



RETRO BLANC ANTISLIP



RETRO NEGRO ANTISLIP



**7 x 60 (G 27) ANTISLIP**  
3" x 23,6" **m<sup>2</sup>**  
x 10 mm.



**21 x 60 (G 38) ANTISLIP**  
8" x 23,6" **m<sup>2</sup>**  
x 10 mm.

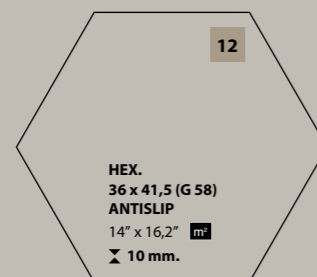

**HEX.**  
**36 x 41,5 (G 58)**  
**ANTISLIP**  
14" x 16,2" **m<sup>2</sup>**  
x 10 mm.

## ESPECIFICACIONES TÉCNICAS · TECHNICAL SPECIFICATIONS



## PIEZAS ESPECIALES · SPECIAL PIECES



**PELDAÑO ANGULAR ANTISLIP**  
**32 x 32/4 (G 17)** 12,5" x 12,5"/1,5"



**ÁNG. PELDAÑO ANG. ANTISLIP**  
**32 x 45/4 (G 18 x 2PZ)** 12,5" x 17,7"/1,5"



**ZÓCALO**  
**9 x 30 (G 06)** 3,5" x 11,8"

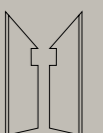

**ZANQUÍN ANG. · IZQ. / DCHA.**  
**9 x 30 (G 10)** 3,5" x 11,8"



# Project Zero



## COLECCIONES · COLLECTIONS

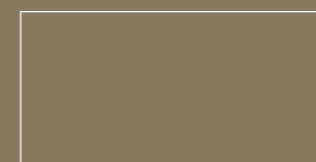

ARTIES 162 - 169  
SAONA 170 - 175



CERLER 176 - 181  
TOSCANA 182 - 187

NATUCER  
*cerámica natural*



Arties Mix Antislip 30,3 x 61,3



**ARTIES, esencia de piedra reinterpretada.**  
*ARTIES, the essence of stone reinterpreted.*

**ARTIES**  
**30,3 x 61,3**



NATUCER  
*cerámica natural*

NEW  
2026

# ARTIES

ARTIES es una colección que reinterpreta la esencia de la piedra desde una mirada contemporánea. Sus superficies evocan la solidez, la textura y la naturalidad de la materia original, trasladando al diseño cerámico un lenguaje auténtico y atemporal.

ARTIES is a collection that reinterprets the essence of stone from a contemporary perspective. Its surfaces evoke the solidity, texture, and natural character of the original material, bringing an authentic and timeless language to ceramic design.

NATUCER  
cerámica natural





Pav. / Floor: Arties Vulcano Antislip 30,3x61,3 · Peldaño Block Arties Vulcano Antislip 120x33/1,4



Pav. / Floor: Arties Mix Antislip 30,3x61,3 · Peldaño Recto Arties Mix Con Goterón Antislip 61,3x32/3 · Borde Piscina Arties Mix Antislip 61,3x45/3 · Esq. Borde Piscina Int. Arties Mix Antislip 61,3x45x63/3



ARTIES VULCANO ANTISLIP



ARTIES IVORY ANTISLIP



ARTIES MIX ANTISLIP



ARTIES WHITE ANTISLIP



ARTIES BEIGE ANTISLIP



ARTIES BALI ANTISLIP



Pav. / Floor: Arties White Antislip 30,3x61,3 · Peldaño Block White Antislip 120x33/1,4  
Vaso Piscina / Pool Basin: Relieve Arties Mix Antislip 30,3x61,3 · Peldaño Block Mix Antislip 120x33/1,4



Pav. / Floor: Arties Ivory Antislip 30,3x61,3 · Peldaño Recto Arties Ivory Con Goterón Antislip 61,3x32/3 · Desbordante Arties Ivory Antislip 50x30,5/2,4  
Esq.Desbordante Int. Arties Ivory Antislip 50x30,5/2,4 · Grating Arties Ivory Antislip 50x25/2,2 · Ang. Grating Arties Ivory Antislip 50x25/2,2  
Vaso Piscina / Pool Basin: Relieve Arties Bali Antislip 30,3x61,3 · Peldaño Block Bali Antislip 120x33/1,4



**RELIEVE ARTIES MIX ANTISLIP**  
30,3 x 61,3 (G 36) 11,9" x 24,1" **m**  
x 10 mm.



**RELIEVE ARTIES BALI ANTISLIP**  
30,3 x 61,3 (G 36) 11,9" x 24,1" **m**  
x 10 mm.

⊖ Escala reducida - Reduced scale



⊖ Escala reducida - Reduced scale



**EXTRUSIONADO PORCELÁNICO**  
EXTRUDED PORCELAIN TILE



**PIEZAS ESPECIALES · SPECIAL PIECES**  
Disponible en todos los colores - Available in all colors

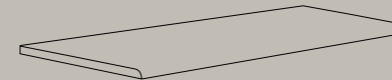

**PELDAÑO BLOCK ANTISLIP**  
120 x 33/1,4 (G 79) 48" x 13"/0,5" **♦**



**PELDAÑO RECTO CON GOTERÓN ANTISLIP**  
61,3 x 32/3 (G 80) 24" x 12,5"/1" **♦**

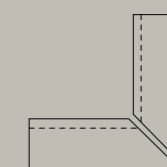

**ÁNG. PELDAÑO RECTO INT. ANTISLIP**  
61,3 x 32 x 46/3 (G 56 x 2)  
24" x 12,5" x 18"/1" **♦**

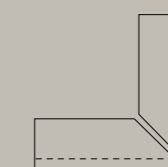

**ÁNG. PELDAÑO RECTO EXT. ANTISLIP**  
61,3 x 32 x 46/3 (G 56 x 2)  
24" x 12,5" x 18"/1" **♦**

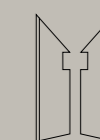

**ZÓCALO RECTO - IZQ. / DRCHA.**  
9 x 30,3 (G 10) 3,5" x 11,9" **♦**



**CUBRECANTO**  
4 x 30/4 (G 13) 1,5" x 11,8"/1,5" **♦**



**COMP. EXT. CUBRECANTO**  
4 x 4 (G 17) 1,5" x 1,5" **♦**



**COMP. INT. CUBRECANTO**  
4 x 4 (G 17) 1,5" x 1,5" **♦**

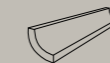

**MEDIA CAÑA INT.**  
4 x 30/4 (G 12) 1,5" x 11,8"/1,5" **♦**



**COMP. INT. MEDIA CAÑA**  
4 x 4 (G 17) 1,5" x 1,5" **♦**



**COMP. EXT. MEDIA CAÑA**  
4 x 4 (G 17) 1,5" x 1,5" **♦**



**ZÓCALO**  
9 x 30,3 (G 06) 3,5" x 11,9" **♦**

**EXTRUSIONADO PORCELÁNICO**  
EXTRUDED PORCELAIN TILE



**PIEZAS ESPECIALES · SPECIAL PIECES**  
Disponible en WHITE, BEIGE, MIX y BALI - Available in WHITE, BEIGE, MIX & BALI

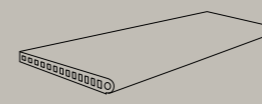

**BORDE PISCINA ANTISLIP**  
61,3 x 28/4 (G 80)  
24" x 11"/1,5" **♦**

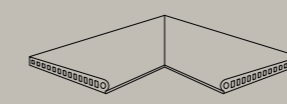

**ESQ. INT. BORDE PISCINA ANTISLIP**  
61,3 x 28 x 43,5/4 (G 56 x 2PZ)  
24" x 11" x 17"/1,5" **♦**

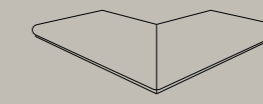

**ESQ. EXT. BORDE PISCINA ANTISLIP**  
61,3 x 28 x 43,5/4 (G 56 x 2PZ)  
24" x 11" x 17"/1,5" **♦**

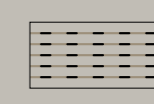

**GRATING ANTISLIP**  
50 x 25/2,2 (G 78) 20" x 10"/1" **♦**

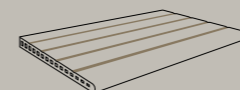

**DESBORDANTE ANTISLIP**  
50 x 30,5/2,4 (G 80)  
20" x 12"/1" **♦**

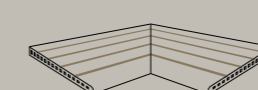

**ESQ. INT. DESBORDANTE ANTISLIP**  
50 x 30,5 x 40/2,4 (G 56 x 2PZ)  
20" x 12" x 16"/1" **♦**

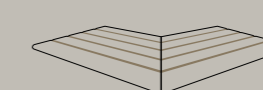

**ESQ. EXT. DESBORDANTE ANTISLIP**  
50 x 30,5 x 40/2,4 (G 56 x 2PZ)  
20" x 12" x 16"/1" **♦**

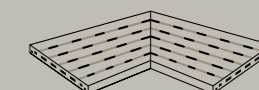

**ÁNGULO GRATING ANTISLIP**  
25 x 50 x 35/2,2 (G 60 x 2PZ)  
10" x 20" x 14"/1" **♦**



Saona Beige Antislip 30,3 x 61,3

**SAONA, equilibrio entre luz, agua y piedra.**  
*SAONA, balance between light, water, and stone.*

**SAONA**  
**30,3 x 61,3**



NATUCER  
*cerámica natural*

NEW  
2026

# SAONA

SAONA es una colección donde sus superficies evocan la serenidad del paisaje mediterráneo, con texturas suaves y matices que recuerdan la piedra erosionada por el mar y la calidez de la luz costera, pensadas para integrarse con naturalidad en espacios que valoran la autenticidad, la calma y la materia como protagonista.

SAONA is a collection whose surfaces evoke the serenity of the Mediterranean landscape, with soft textures and nuances that recall stone shaped by the sea and the warmth of coastal light, designed to blend naturally into spaces that value authenticity, calm, and material as the central element.

NATUCER  
*cerámica natural*



Pav. / Floor: Saona Beige Antislip 30,3x61,3 • Peldaño Block Saona Beige 120x33/1,4 • Borde Piscina Saona Beige 61,3x28/4



Pav. / Floor: Saona White Antislip 30,3x61,3 - Peldaño Block Saona White Antislip 120x33/1,4 - Borde Piscina Saona White Antislip 61,3x28/4 - Esq. Borde Piscina Int. Saona White Antislip 61,3x28 x 43,5/4



Pav. / Floor: Saona Grey Antislip 30,3x61,3 - Peldaño Recto Con Goterón Saona Grey Antislip 61,3x32/3 - Zócalo Saona Grey 9x30,3 - Zanquín Recto Saona Grey 9x30,3 - Ángulo Peldaño Recto Ext. Saona Grey Antislip 61,3x32x46/3

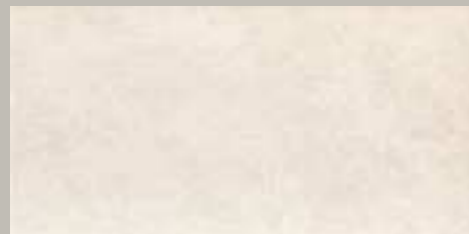

SAONA WHITE ANTISLIP  
30,3 x 61,3 (G 36) 12" x 24"  $m^2$   
± 9 mm.

24



SAONA BEIGE ANTISLIP  
30,3 x 61,3 (G 36) 12" x 24"  $m^2$   
± 9 mm.

24



SAONA GREY ANTISLIP  
30,3 x 61,3 (G 36) 12" x 24"  $m^2$   
± 9 mm.

24

EXTRUSIONADO PORCELÁNICO  
EXTRUDED PORCELAIN TILE

PIEZAS ESPECIALES · SPECIAL PIECES

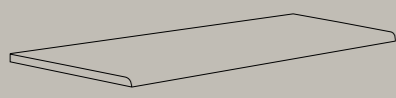

PELDAÑO BLOCK ANTISLIP  
120 x 33/1,4 (G 79) 48" x 13"/0,5" ♦

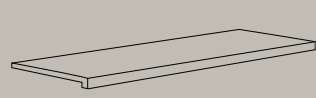

PELDAÑO RECTO CON GOTERÓN ANTISLIP  
61,3 x 32/3 (G 80) 24" x 12,5"/1" ♦

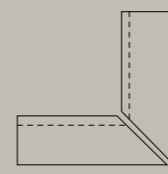

ÁNG. PELDAÑO RECTO INT. ANTISLIP  
61,3 x 32 x 46/3 (G 56 x 2)  
24" x 12,5" x 18"/1" ♦

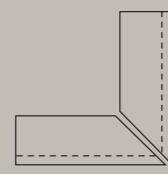

ÁNG. PELDAÑO RECTO EXT. ANTISLIP  
61,3 x 32 x 46/3 (G 56 x 2)  
24" x 12,5" x 18"/1" ♦

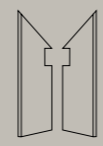

ZANQUÍN RECTO · IZQ. / DRCHA.  
9 x 30,3 (G 10) 3,5" x 11,9" ♦



CUBRECANTO  
4 x 30/4 (G 13) 1,5" x 11,8"/1,5" ♦



COMP. EXT. CUBRECANTO  
4 x 4 (G 17) 1,5" x 1,5" ♦



COMP. INT. CUBRECANTO  
4 x 4 (G 17) 1,5" x 1,5" ♦



MEDIA CAÑA INT.  
4 x 30/4 (G 12) 1,5" x 11,8"/1,5" ♦



COMP. INT. MEDIA CAÑA  
4 x 4 (G 17) 1,5" x 1,5" ♦



COMP. EXT. MEDIA CAÑA  
4 x 4 (G 17) 1,5" x 1,5" ♦



ZÓCALO  
9 x 30,3 (G 06) 3,5" x 11,9" ♦

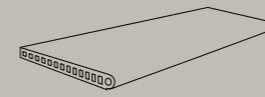

BORDE PISCINA ANTISLIP  
61,3 x 28/4 (G 80)  
24" x 11"/1,5" ♦

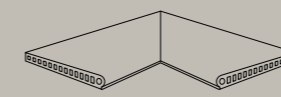

ESQ. INT. BORDE PISCINA ANTISLIP  
61,3 x 28 x 43,5/4 (G 56 x 2PZ)  
24" x 11" x 17"/1,5" ♦

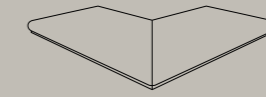

ESQ. EXT. BORDE PISCINA ANTISLIP  
61,3 x 28 x 43,5/4 (G 56 x 2PZ)  
24" x 11" x 17"/1,5" ♦

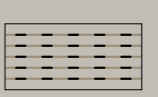

GRATING ANTISLIP  
50 x 25/2,2 (G 78) 20" x 10"/1" ♦

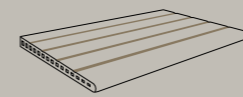

DESBORDANTE ANTISLIP  
50 x 30,5/2,4 (G 80)  
20" x 12"/1" ♦

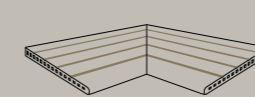

ESQ. INT. DESBORDANTE ANTISLIP  
50 x 30,5 x 40/2,4 (G 56 x 2PZ)  
20" x 12" x 16"/1" ♦

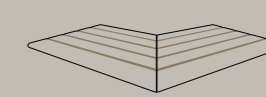

ESQ. EXT. DESBORDANTE ANTISLIP  
50 x 30,5 x 40/2,4 (G 56 x 2PZ)  
20" x 12" x 16"/1" ♦

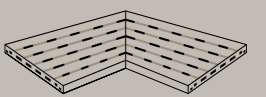

ÁNGULO GRATING ANTISLIP  
25 x 50 x 35/2,2 (G 60 x 2PZ)  
10" x 20" x 14"/1" ♦

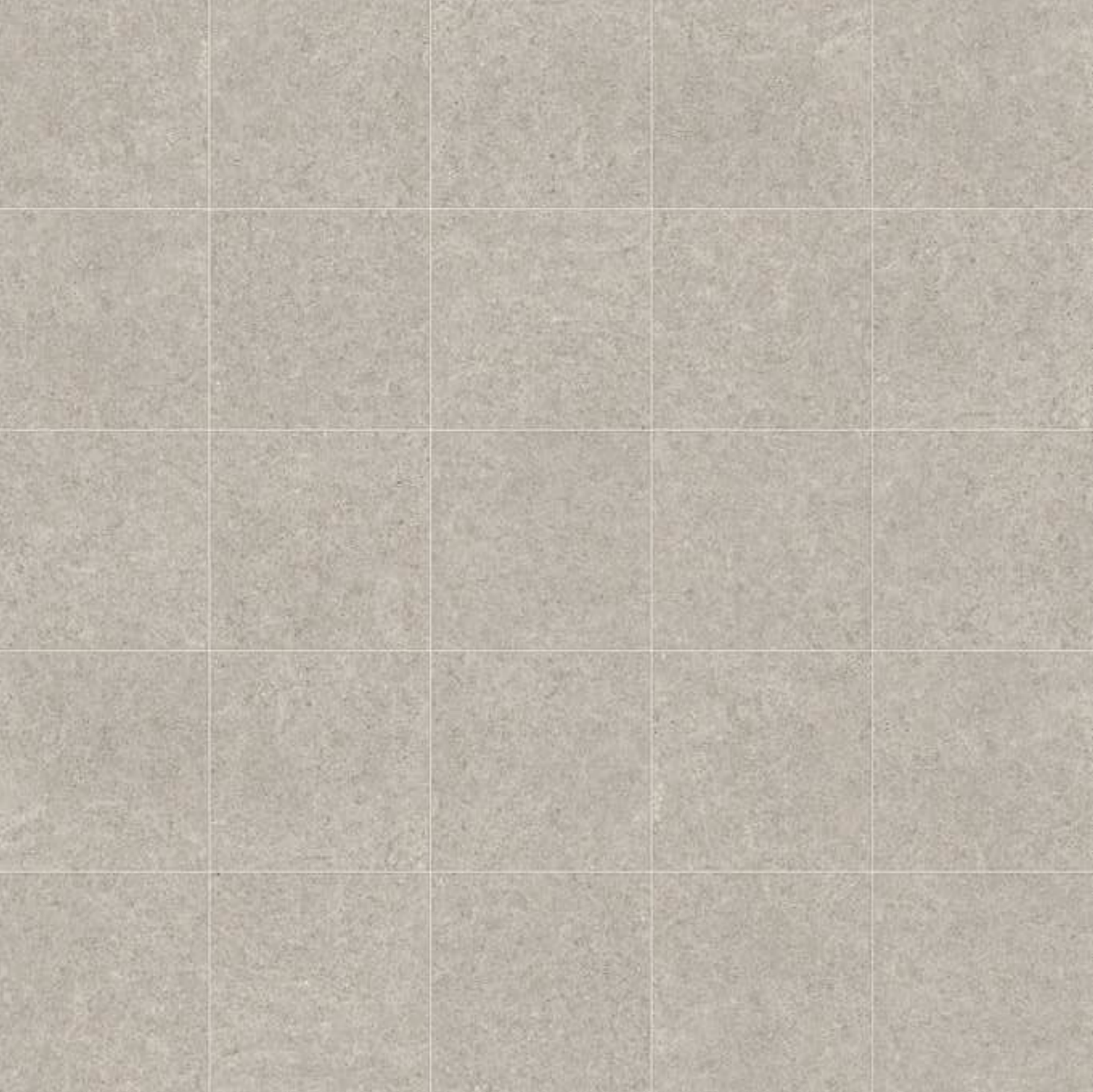

Cerler Greige Antislip 33,3 x 33,3

**CERLER, la esencia de la alta montaña hecha materia.**  
*CERLER, the essence of the high mountains made material.*

**CERLER**  
**33,3 x 33,3**



NATUCER  
*cerámica natural*

NEW  
2026

# CERLER

CERLER es una colección inspirada en la alta montaña, donde nieve, roca y tradición se funden en un paisaje de pureza y calma.

Sus superficies evocan la fuerza de la piedra y la calidez de la madera.

CERLER is a collection inspired by the high mountains, where snow, rock, and tradition blend into a landscape of purity and calm.

Its surfaces evoke the strength of stone and the warmth of wood.

NATUCER  
cerámica natural



Pav. / Floor: Cerler Greige Antislip 33,3x33,3  
Rev. / Wall: Cerler Greige Antislip 33,3x33,3



Pav. / Floor: Cerler Greige Antislip 33,3x33,3 - Peldaño Recto Con Goterón Cerler Greige Antislip 33,3x33,3/3 - Vierteaguas Cerler Greige Antislip 15x33,3/4



Pav. / Floor: Cerler Ivory Antislip 33,3x33,3 - Pasamanos Cerler Ivory 1 Antislip 8x33,3/4  
Rev. / Wall: Alquézar Arena 20x120



30

**CERLER GREIGE ANTISLIP**  
33,3 x 33,3 (G 36) 13,1" x 13,1" **m²**  
Σ 9 mm.



30

**CERLER WHITE ANTISLIP**  
33,3 x 33,3 (G 36) 13,1" x 13,1" **m²**  
Σ 9 mm.



30

**CERLER IVORY ANTISLIP**  
33,3 x 33,3 (G 36) 13,1" x 13,1" **m²**  
Σ 9 mm.

EXTRUSIONADO PORCELÁNICO  
EXTRUDED PORCELAIN TILE

PIEZAS ESPECIALES · SPECIAL PIECES



**PELDAÑO RECTO CON GOTERÓN ANTISLIP**  
33,3 x 33,3/3 (G 17) 13,1" x 12,6"/1" ◆



**VIERTEAGUAS ANTISLIP**  
15 x 33,3/4 (G 12) 5,9" x 13,1"/1,5" ◆



**PASAMANOS ANTISLIP**  
18 x 33,3/4 (G 30) 7" x 13,1"/1,5" ◆



**ZÓCALO**  
8 x 33,3 (G 06) 3" x 13,1" ◆

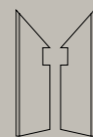

**ZANQUÍN RECTO. · IZQ. / DRCHA.**  
8 x 33,3 (G 10) 3" x 13,1" ◆



Toscana Arena Antislip 33,3 x 33,3



**TOSCANA, la elegancia sencilla de la arquitectura tradicional.**  
*TOSCANA, the simple elegance of traditional architecture.*

# TOSCANA

**33,3 x 33,3**

NATUCER  
*cerámica natural*



NEW  
2026

# TOSCANA

TOSCANA es una colección inspirada en la belleza serena del paisaje italiano, donde la piedra, la tierra y la arquitectura tradicional se combinan en una estética cálida y atemporal. Sus superficies evocan tonos naturales y texturas suaves que aportan equilibrio, elegancia y autenticidad, creando espacios con carácter propio y un marcado aire mediterráneo.

TOSCANA is a collection inspired by the serene beauty of the Italian landscape, where stone, earth, and traditional architecture come together in a warm and timeless aesthetic. Its surfaces evoke natural tones and soft textures that bring balance, elegance, and authenticity, creating spaces with a distinctive character and a strong Mediterranean feel.

NATUCER  
cerámica natural





Pav. / Floor: Toscana Natural Antislip 33,3x33,3 - Pasamanos Toscana Natural Antislip 18x33,3/4 - Peldaño Curvo Toscana Natural Antislip 33,3x33,3/4 - Zócalo Toscana Natural 8x33,3 - Zanquín Curvo Toscana Natural 8x33,3



12

**TOSCANA ARENA ANTISLIP**  
33,3 x 33,3 (G 36) 13,1" x 13,1" m<sup>2</sup>  
± 9 mm.



12

**TOSCANA NATURAL ANTISLIP**  
33,3 x 33,3 (G 36) 13,1" x 13,1" m<sup>2</sup>  
± 9 mm.

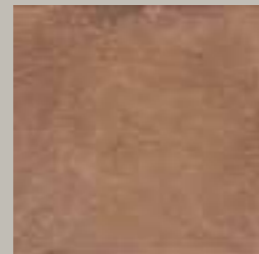

12

**TOSCANA RÚSTICO ANTISLIP**  
33,3 x 33,3 (G 36) 13,1" x 13,1" m<sup>2</sup>  
± 9 mm.

EXTRUSIONADO PORCELÁNICO  
EXTRUDED PORCELAIN TILE

PIEZAS ESPECIALES - SPECIAL PIECES



**PELDAÑO CURVO ANTISLIP**  
33,3 x 33,3/4 (G 17) 13,1" x 12,6"/1" ♦

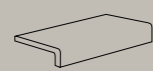

**VIERTEAGUAS ANTISLIP**  
15 x 33,3/4 (G 12) 5,9" x 13,1"/1,5" ♦

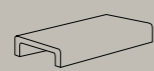

**PASAMANOS ANTISLIP**  
18 x 33,3/4 (G 30) 7" x 13,1"/1,5" ♦

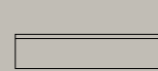

**ZÓCALO**  
8 x 33,3 (G 06) 3" x 13,1" ♦

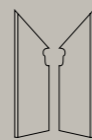

**ZANQUÍN CURVO. - IZQ. / DRCHA.**  
8 x 33,3 (G 10) 3" x 13,1" ♦



Pav. / Floor: Toscana Rústico Antislip 33,3x33,3 - Pasamanos Toscana Rústico Antislip 18x33,3/4 - Peldaño Curvo Toscana Rústico Antislip 33,3x33,3/4 - Zócalo Toscana Rústico 8x33,3



## COLECCIONES · COLLECTIONS

### EXTRUSIONADO PORCELÁNICO EXTRUDED PORCELAIN TILE

CAPRI	207
FRAME	232 - 233
MARE NOSTRUM	238 - 239
TABARCA	228 - 231
TEMPO	234 - 237

### PORCELÁNICO PORCELAIN TILE

HERITAGE CLAY	190 - 195
LINEAGE	208 - 213
POOL	224 - 225
SARSEN STONE	196 - 201

### PASTA BLANCA WHITE BODY

AUSTRAL	218
COOL	204 - 205
EVOKE	216 - 217
FIKA	214 - 215
HERITAGE CLAY	190 - 195
LIVERPOOL	206
PIASTRELLA MIX	222 - 223
STOW/STOW MIX	226 - 227
VEGA	219
WABI SABI	202 - 203
ZELLIGE	220 - 221

# Revestimiento

wall tile





Heritage Clay Emerald

Heritage Clay Emerald 6,5x20

Heritage Clay Emerald 15x15

**HERITAGE CLAY: diversidad cromática con una identidad única.**  
*HERITAGE CLAY: chromatic diversity with a unique identity.*

# HERITAGE CLAY



NATUCER  
*cerámica natural*

NEW  
2026

# HERITAGE CLAY

HERITAGE CLAY es una colección de revestimiento cerámico que reinterpreta la belleza natural de la piedra con un enfoque actual. Sus piezas crean espacios dinámicos sin perder coherencia visual gracias a una textura continua que unifica toda la serie. Esta versatilidad permite jugar con composiciones y adaptarse a diferentes estilos y proyectos. Heritage Clay es la elección perfecta para quienes buscan un equilibrio entre diseño, calidez y una estética atemporal con carácter propio.

HERITAGE CLAY is a ceramic wall tile collection that reinterprets the natural beauty of stone with a contemporary approach. Its pieces create dynamic spaces while maintaining visual coherence thanks to a continuous texture that unifies the entire series. This versatility allows for creative compositions and adaptation to different styles and projects. Heritage Clay is the perfect choice for those seeking a balance between design, warmth, and a timeless aesthetic with its own character.

NATUCER  
cerámica natural



Rev. / Wall: Heritage Clay Emerald 60x120 · Heritage Clay Emerald 6,5x20  
Pav. / Floor: Sherwood Nut 25x150

# HERITAGE CLAY

PORCELÁNICO  
PORCELAIN TILE

NEW  
2026

CLASE I - R 9  
UNE-EN-16165  
ANEXO C - B



Rev. / Wall: Heritage Clay Cotto 6,5x20 - Heritage Clay Cotto 30x60 - Heritage Clay Cotto 120x120  
Pav. / Floor: Heritage Clay Cotto 30x60



Rev. / Wall: Heritage Clay Cotto 15x15 - Heritage Clay Greige 60x120  
Pav. / Floor: Sherwood Nut 25x150



Rev. / Wall: Heritage Clay Ivory 6,5x20

9

6,5 x 20 (G 68)  
2,5" x 8"   
x 8 mm.

9

15 x 15 (G 68)  
6" x 6"   
x 8 mm.

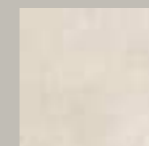

HERITAGE CLAY  
WHITE

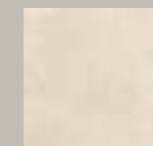

HERITAGE CLAY  
IVORY

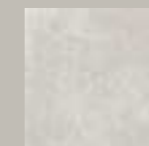

HERITAGE CLAY  
PEARL



HERITAGE CLAY  
GREIGE

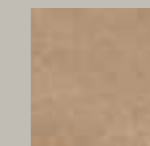

HERITAGE CLAY  
COTTO



HERITAGE CLAY  
BLUE



HERITAGE CLAY  
EMERALD



Sarsen stone White 5x25

Sarsen stone White 15x15

**SARSEN STONE, Pureza y frescura en equilibrio.**  
*SARSEN STONE: Purity and freshness in balance.*

# SARSEN STONE



NATUCER  
*cerámica natural*

NEW  
2026

# SARSEN STONE

SARSEN STONE, presenta dos tonalidades cuidadosamente seleccionadas: un blanco luminoso y un turquise Bali lleno de frescura. La combinación de ambos colores permite crear espacios equilibrados y llenos de personalidad, donde la claridad y la vitalidad conviven en armonía. Su textura, fiel al carácter natural del material, aporta profundidad y autenticidad, convirtiendo cada superficie en un elemento protagonista.

SARSEN STONE presents two carefully selected tones: a luminous white and a fresh Bali turquoise. The combination of both colors allows for the creation of balanced, characterful spaces, where clarity and vitality coexist in harmony. Its texture, faithful to the natural character of the material, adds depth and authenticity, turning every surface into a focal element.

NATUCER  
*cerámica natural*



Rev. / Wall: Sarsen Stone White 5x25 · Sarsen Stone White 15x15 · Luxor Clay 8x39x4  
Pav. / Floor: Sherwood Linde 25x150

# SARSEN STONE

PORCELÁNICO  
PORCELAIN TILE

NEW  
2026

CLASE I - R 9  
UNE-EN-16165  
ANEXO C - B



Rev. / Wall: Sarsen Stone White 5x25 - Sarsen Stone White 120x120  
Pav. / Floor: Sarsen Stone White 120x120

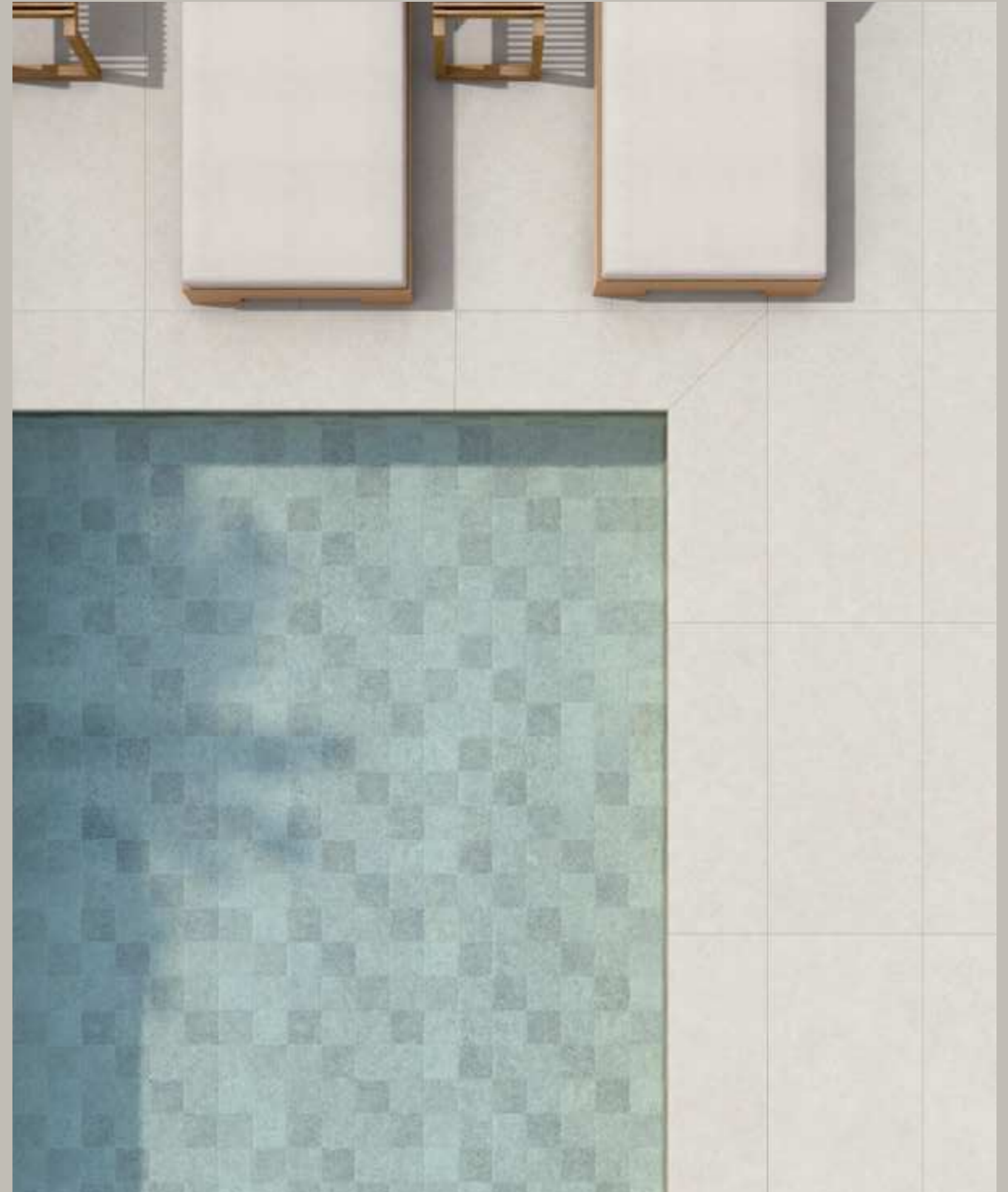

Pav. / Floor: Sarsen Stone White Antislip 60x120 · Peldaño Recto Sarsen Stone White Antislip 120x32/3 · Ángulo Peldaño Recto Int. Sarsen Stone White Antislip 120x32x45/3  
Vaso Piscina / Pool Basin: Sarsen Stone Turquoise Bali 15x15

\* Solo disponible en WHITE  
\* Only available in WHITE

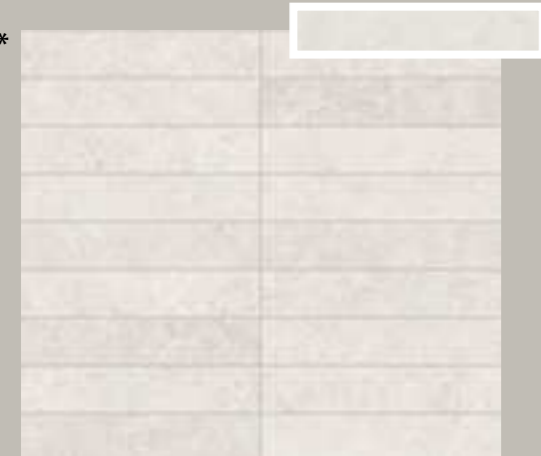

SARSEN STONE WHITE  
5 x 25 (G 68) 2' x 10' m²  
x 8 mm. **6**



SARSEN STONE WHITE  
15 x 15 (G 68) 6' x 6' m²  
x 8 mm. **6**



SARSEN STONE TURQUOISE BALI  
15 x 15 (G 68) 6' x 6' m²  
x 8 mm. **6**

# WABI SABI

Pasta Blanca  
WHITE BODY



MATE  
MATT



BRILLO  
GLOSS



Rev. / Wall: **Wabi Sabi Clear Matt 7x40**



Rev. / Wall: **Wabi Sabi White 7x40**



Rev. / Wall: **Wabi Sabi Aqua 7x40**



MATE  
MATT



**WABI SABI CLEAR MATT 7 x 40 (G 77) 3" x 16" m²**  
x 9 mm.



**WABI SABI GRAY MATT 7 x 40 (G 77) 3" x 16" m²**  
x 9 mm.



BRILLO  
GLOSS



**WABI SABI WHITE 7 x 40 (G 77) 3" x 16" m²**  
x 9 mm.



**WABI SABI AQUA 7 x 40 (G 77) 3" x 16" m²**  
x 9 mm.



SPECIAL ORDER  
BAJO PEDIDO



**WABI SABI NUDE MATT 7 x 40 (G 77) 3" x 16" m²**  
x 9 mm.



**WABI SABI CLAY MATT 7 x 40 (G 77) 3" x 16" m²**  
x 9 mm.



**WABI SABI DARK MATT 7 x 40 (G 77) 3" x 16" m²**  
x 9 mm.



**WABI SABI ASH 7 x 40 (G 77) 3" x 16" m²**  
x 9 mm.



**WABI SABI OLIVE 7 x 40 (G 77) 3" x 16" m²**  
x 9 mm.

PIEZAS ESPECIALES · SPECIAL PIECES

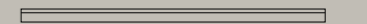

**DEMI-BULLNOSE**  
1,5 x 30 (G 07) 0,6" x 11,8" ◆



Rev. / Wall: **Cool White 5x30**



Rev. / Wall: **Cool Ash 5x30**



Rev. / Wall: **Cool Emerald 5x30**



**COOL WHITE 5 x 30 (G 77)** 2" x 12" **m**  
x 9 mm.



**COOL ASH 5 x 30 (G 77)** 2" x 12" **m**  
x 9 mm.



**COOL LATTE 5 x 30 (G 77)** 2" x 12" **m**  
x 9 mm.



**COOL EMERALD 5 x 30 (G 77)** 2" x 12" **m**  
x 9 mm.



**COOL NAVY 5 x 30 (G 77)** 2" x 12" **m**  
x 9 mm.

PIEZAS ESPECIALES - SPECIAL PIECES

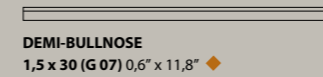

**DEMI-BULLNOSE**  
1,5 x 30 (G 07) 0,6" x 11,8" ◆



Rev. / Wall: **Cool Navy 5x30**

# LIVERPOOL

Pasta Blanca  
WHITE BODY



Rev. / Wall: Liverpool White 5x30



LIVERPOOL WHITE 5 x 30 (G 77) 2" x 12" **m²**  
x 9 mm.



LIVERPOOL GRAY 5 x 30 (G 77) 2" x 12" **m²**  
x 9 mm.



LIVERPOOL NUDE 5 x 30 (G 77) 2" x 12" **m²**  
x 9 mm.



LIVERPOOL KALE 5 x 30 (G 77) 2" x 12" **m²**  
x 9 mm.

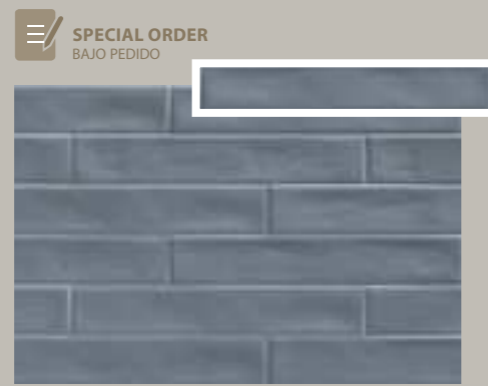

LIVERPOOL NAVY 5 x 30 (G 77) 2" x 12" **m²**  
x 9 mm.



LIVERPOOL CLAY 5 x 30 (G 77) 2" x 12" **m²**  
x 9 mm.

PIEZAS ESPECIALES - SPECIAL PIECES



DEMI-BULLNOSE  
1,5 x 30 (G 07) 0,6" x 11,8" ◆

# CAPRI

EXTRUSIONADO PORCELÁNICO  
EXTRUDED PORCELAIN TILE



Rev. / Wall: Capri Nieve 6,5x25

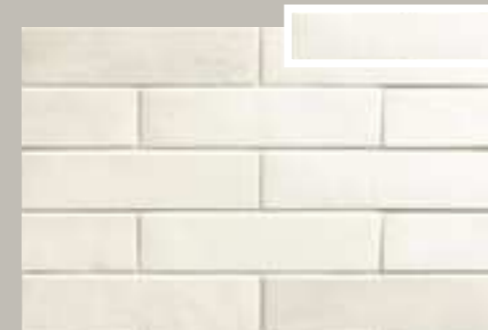

CAPRI NEVE 6,5 x 25 (G 56) 2,5" x 10" **m²**  
x 11 mm.



CAPRI NERO 6,5 x 25 (G 56) 2,5" x 10" **m²**  
x 11 mm.



CAPRI OLIVA 6,5 x 25 (G 56) 2,5" x 10" **m²**  
x 11 mm.



CAPRI INDIGO 6,5 x 25 (G 56) 2,5" x 10" **m²**  
x 11 mm.

PIEZAS ESPECIALES - SPECIAL PIECES



DEMI-BULLNOSE  
1,5 x 30 (G 07) 0,6" x 11,8" ◆



Lineage Sage Green 6,5x20

**LINEAGE**, el brillo que define espacios con carácter.  
*LINEAGE, the shine that defines spaces with character.*

**LINEAGE**



NATUCER  
*cerámica natural*

NEW  
2026

# LINEAGE

LINEAGE es una colección de revestimiento cerámico en acabado brillante que aporta luminosidad y carácter a cualquier espacio. Permite múltiples composiciones, ofreciendo dinamismo y versatilidad en el diseño. Su superficie porcelánica refleja la luz y realza cada pieza, creando ambientes vibrantes, elegantes y llenos de personalidad. LINEAGE es la solución ideal para quienes buscan combinar funcionalidad, diseño y un acabado visualmente impactante.

LINEAGE is a glossy ceramic wall tile collection that brings luminosity and character to any space. It allows for multiple compositions, offering dynamism and versatility in design. Its porcelain surface reflects light and enhances each piece, creating vibrant, elegant, and personality-filled environments. LINEAGE is the ideal solution for those seeking to combine functionality, design, and a visually striking finish.

NATUCER  
cerámica natural



Rev. / Wall: Lineage Sage Green 6,5x20 · Sarsen Stone Ivory 120x120  
Pav. / Floor: Sarsen Stone Ivory Antislip 120x120



Rev. / Wall: **Lineage Ivory 6,5x20** - Demi-bullnose **Lineage Ivory 1,5x30**



Rev. / Wall: **Lineage Dark Coffee 6,5x20** - **Sarsen Stone Ivory 120x120**  
Pav. / Floor: **Sarsen Stone Ivory 120x120**



Rev. / Wall: **Lineage Sage Green 6,5x20**



**LINEAGE WHITE**  
6,5 x 20 (G 68) 2,5" x 8" **m²**  
x 8 mm.



**LINEAGE IVORY**  
6,5 x 20 (G 68) 2,5" x 8" **m²**  
x 8 mm.



**LINEAGE HONEY**  
6,5 x 20 (G 68) 2,5" x 8" **m²**  
x 8 mm.



**LINEAGE SAGE GREEN**  
6,5 x 20 (G 68) 2,5" x 8" **m²**  
x 8 mm.



**LINEAGE SKY BLUE**  
6,5 x 20 (G 68) 2,5" x 8" **m²**  
x 8 mm.



**LINEAGE IMPERIAL BLUE**  
6,5 x 20 (G 68) 2,5" x 8" **m²**  
x 8 mm.



**LINEAGE GRAPHITE**  
6,5 x 20 (G 68) 2,5" x 8" **m²**  
x 8 mm.

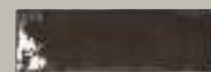

**LINEAGE DARK COFFEE**  
6,5 x 20 (G 68) 2,5" x 8" **m²**  
x 8 mm.

PIEZAS ESPECIALES - SPECIAL PIECES



**DEMI-BULLNOSE**  
1,5 x 30 (G 07) 0,6" x 11,8" ◆



Rev. / Wall: **Lineage Dark Coffee 6,5x20**



Rev. / Wall: **Fika Cotto 10x10**  
Pav. / Floor: **Argile Palermo 45x45**



Rev. / Wall: **Fika Marsala 10x10**



Rev. / Wall: **Fika Bianco 10x10** - **Sarsen Stone Ivory 120x120**  
Pav. / Floor: **Sarsen Stone Ivory 120x120**



FIKA OFF WHITE



FIKA COTTO

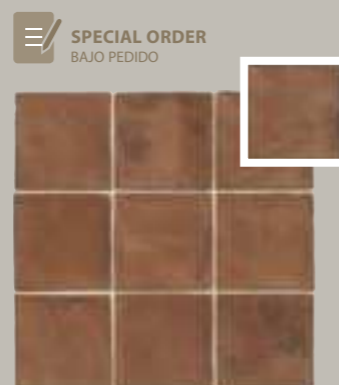

FIKA MARSALA



FIKA FOSSIL



FIKA BIANCO



FIKA SKY



FIKA KALE

PIEZAS ESPECIALES - SPECIAL PIECES

**DEMI-BULLNOSE**  
1,5 x 30 (G 07) 0,6" x 11,8" ◆

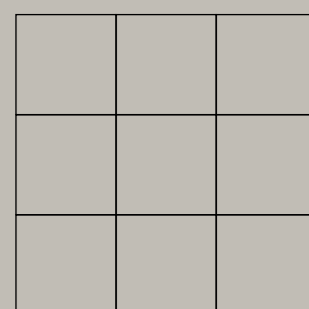

**20**  
ENM. 30,5 x 30,5 (G 60)  
12" x 12" m<sup>2</sup>  
✂ 9 mm.

**24**  
10 x 10 (G 77)  
4" x 4" m<sup>2</sup>  
✂ 9 mm.

**12**  
10 x 20 (G 77)  
4" x 8" m<sup>2</sup>  
✂ 10 mm.



Solo disponible en SKY, BIANCO y OFF WHITE  
Only available in SKY, BIANCO, and OFF WHITE



Rev. / Wall: **Fika Kale 10x10**



FIKA CLEAR 20 x 60 (G 27) 8" x 24" m<sup>2</sup>  
✂ 10 mm.



FIKA BIANCO 20 x 60 (G 27) 8" x 24" m<sup>2</sup>  
✂ 10 mm.

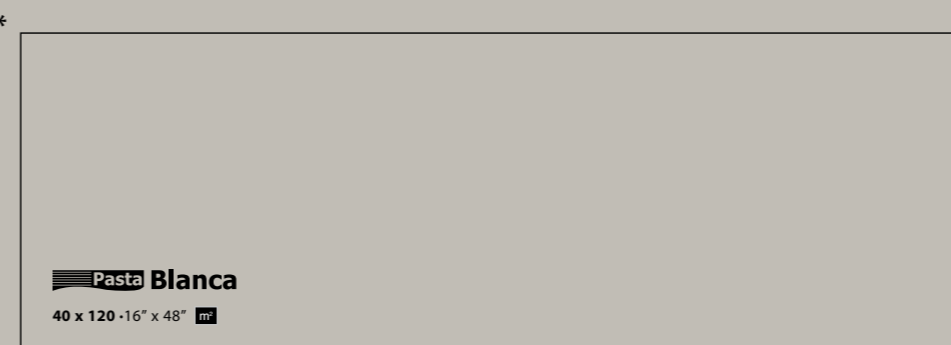

Pasta Blanca  
40 x 120 - 16" x 48" m<sup>2</sup>

\* REVESTIMIENTO COORDINADO - COORDINATED WALL TILE

La serie FIKA combina con las bases de la series AUSTRAL pág. 218 y la serie VEGA pág. 219

The FIKA series is compatible with the bases from the AUSTRAL series page 218 and the VEGA series page 219



**AUSTRAL (G 69)**  
Disponible en WHITE y BEIGE  
Available in WHITE & BEIGE



**VEGA (G 86)**  
Disponible en BIANCO  
Available in BIANCO



Rev. / Wall: Evoke Lake 6,5x26 - Austral Bianco 40x120



Rev. / Wall: Evoke Kale 6,5x26



Rev. / Wall: Evoke Kale 6,5x26 - Sarsen Stone Greige 120x120  
Pav. / Floor: Sarsen Stone Greige 120x120

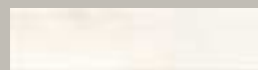

**EVOKE CLEAR**  
6,5 x 26 (G 76) 2,5" x 10,2"   
x 9 mm.



**EVOKE LINEN**  
6,5 x 26 (G 76) 2,5" x 10,2"   
x 9 mm.



**EVOKE CLAY**  
6,5 x 26 (G 76) 2,5" x 10,2"   
x 9 mm.



**EVOKE KALE**  
6,5 x 26 (G 76) 2,5" x 10,2"   
x 9 mm.



**EVOKE LAKE**  
6,5 x 26 (G 76) 2,5" x 10,2"   
x 9 mm.



**SPECIAL ORDER**  
BAJO PEDIDO



**EVOKE SKIN**  
6,5 x 26 (G 76) 2,5" x 10,2"   
x 9 mm.



**EVOKE CEMENT**  
6,5 x 26 (G 76) 2,5" x 10,2"   
x 9 mm.



**EVOKE DARK**  
6,5 x 26 (G 76) 2,5" x 10,2"   
x 9 mm.

PIEZAS ESPECIALES · SPECIAL PIECES



**PENCIL**  
2,5 x 30 (G 10) 1" x 11,8"



**DEMI-BULLNOSE**  
1,5 x 30 (G 07) 0,6" x 11,8"

\*

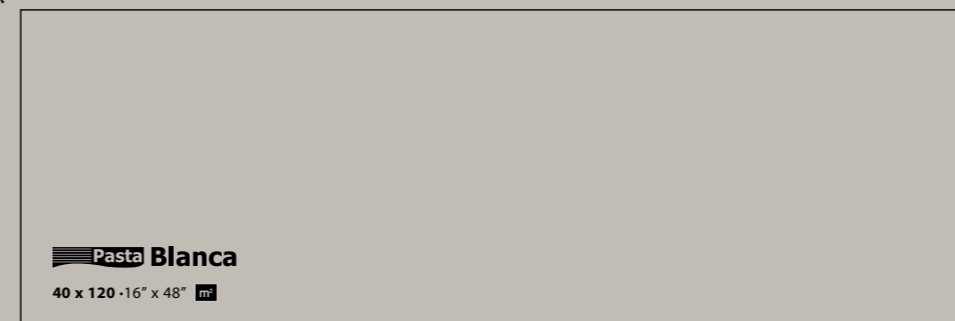

\* REVESTIMIENTO COORDINADO - COORDINATED WALL TILE

La serie FIKA combina con las bases de la series AUSTRAL pág. 218 y la serie VEGA pág. 219

The FIKA series is compatible with the bases from the AUSTRAL series page 218 and the VEGA series page 219



**AUSTRAL (G 69)**  
Disponible en WHITE y BEIGE  
Available in WHITE & BEIGE



**VEGA (G 86)**  
Disponible en BIANCO  
Available in BIANCO

# AUSTRAL

Pasta Blanca  
WHITE BODY



RECT



Rev. / Wall: **Austral White 40x120**



Rev. / Wall: **Austral Beige 40x120**

# VEGA

Pasta Blanca  
WHITE BODY

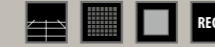

RECT



Rev. / Wall: **Vega Bianco 40x120**



Rev. / Wall: **Vega Bianco 40x120**

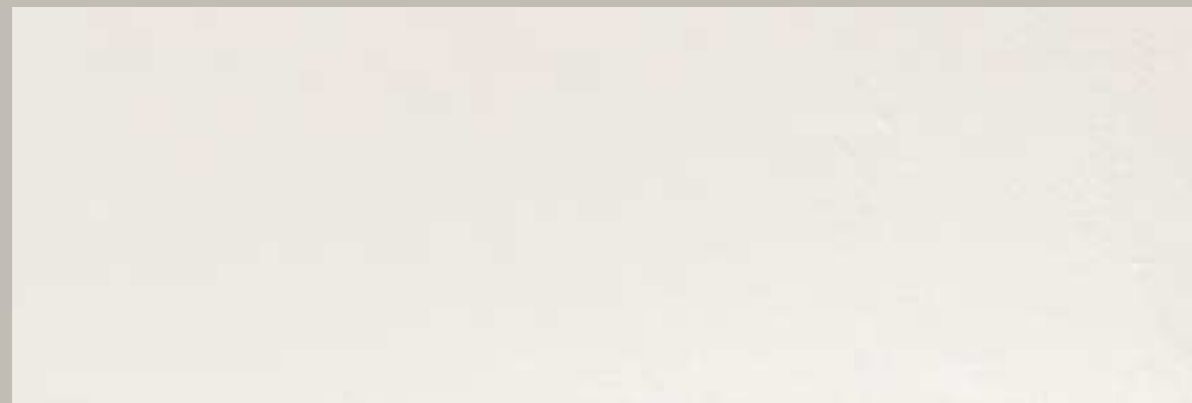

**AUSTRAL WHITE 40 x 120 (G 69) 16" x 48" **  
x 11 mm.

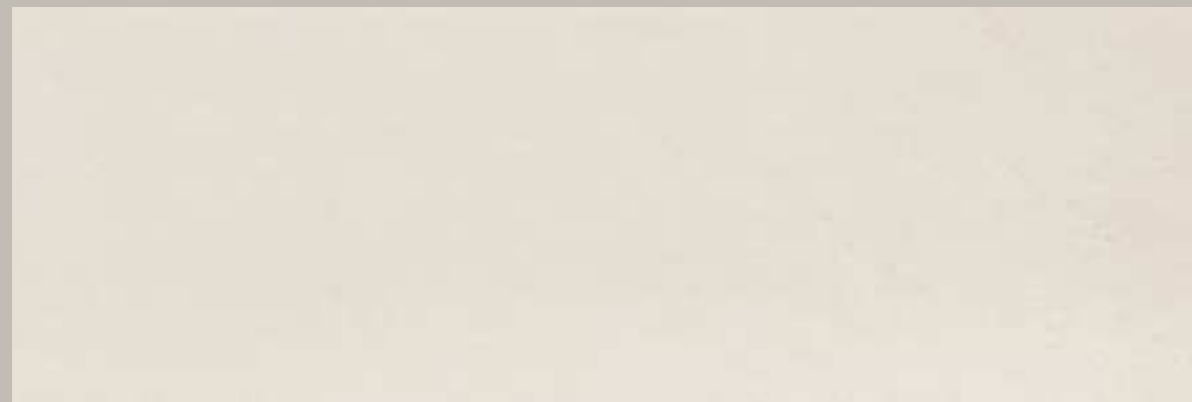

**AUSTRAL BEIGE 40 x 120 (G 69) 16" x 48" **  
x 11 mm.



**VEGA BIANCO 40 x 120 (G 86) 16" x 48" **  
x 11 mm.

# ZELLIGE

Pasta Blanca  
WHITE BODY



Rev. / Wall: Zellige Grey 6,2x25



Rev. / Wall: Zellige White 6,2x25



Rev. / Wall: Zellige Green 6,2x25

BRILLO  
GLOSS

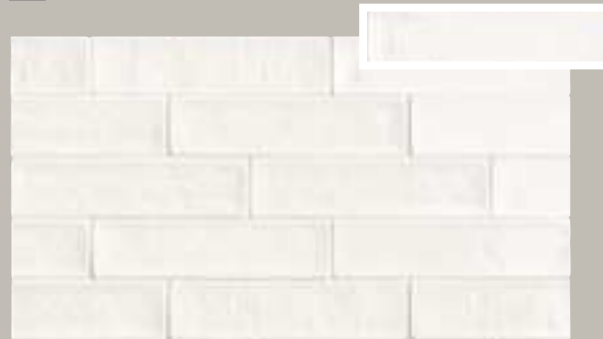

ZELLIGE WHITE 6,2 x 25 (G 27) 2,5" x 10" m<sup>2</sup>  
x 9 mm.

BRILLO  
GLOSS

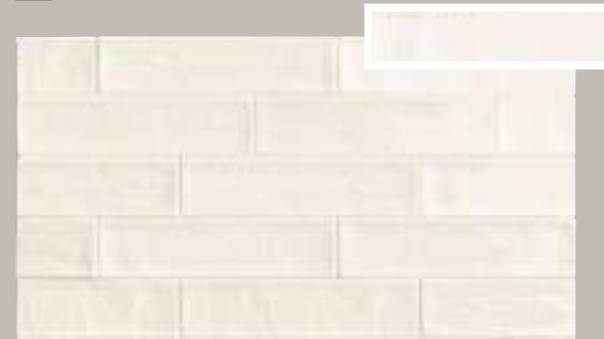

ZELLIGE BEIGE 6,2 x 25 (G 27) 2,5" x 10" m<sup>2</sup>  
x 9 mm.



ZELLIGE BLUE 6,2 x 25 (G 27) 2,5" x 10" m<sup>2</sup>  
x 9 mm.

SPECIAL ORDER  
BAJO PEDIDO



ZELLIGE ROSE 6,2 x 25 (G 27) 2,5" x 10" m<sup>2</sup>  
x 9 mm.

MATE  
MATT

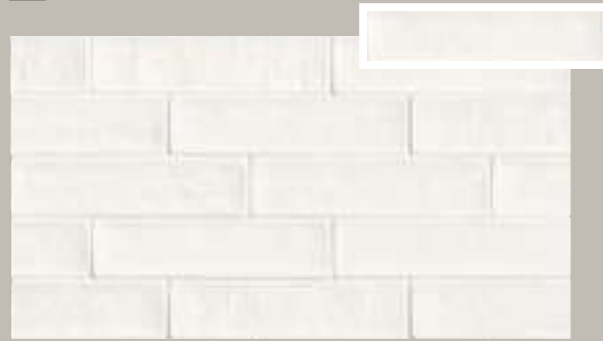

ZELLIGE WHITE MATT 6,2 x 25 (G 27) 2,5" x 10" m<sup>2</sup>  
x 9 mm.

BRILLO  
GLOSS



ZELLIGE GREY 6,2 x 25 (G 27) 2,5" x 10" m<sup>2</sup>  
x 9 mm.



ZELLIGE GREEN 6,2 x 25 (G 27) 2,5" x 10" m<sup>2</sup>  
x 9 mm.



ZELLIGE BLACK 6,2 x 25 (G 27) 2,5" x 10" m<sup>2</sup>  
x 9 mm.

PIEZAS ESPECIALES · SPECIAL PIECES



DEMI-BULLNOSE  
1,5 x 30 (G 07) 0,6" x 11,8" ◆

# PIASTRELLA MIX

Pasta Blanca  
WHITE BODY

La serie PIASTRELLA MIX combina con la serie CONVEX MIX - Ver serie en el catálogo CUORE  
PIASTRELLA MIX combines with CONVEX MIX collection - Check series in the CUORE catalogue



Rev. / Wall: PIASTRELLA Mix Turchese 5x25



Rev. / Wall: PIASTRELLA Mix Olive 5x25



Rev. / Wall: PIASTRELLA Mix Acqua 5x25

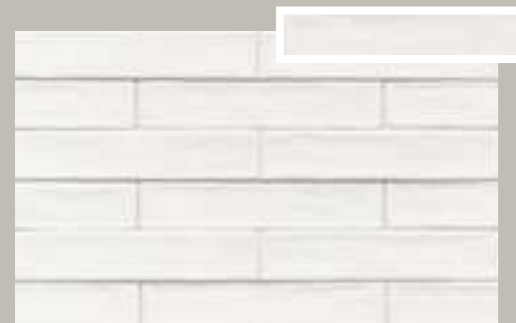

PIASTRELLA NATURALE 5 x 25 (G 27) 2" x 10"   
x 10 mm.



PIASTRELLA MIX ROSE 5 x 25 (G 27) 2" x 10"   
x 10 mm.



PIASTRELLA MIX ASH 5 x 25 (G 27) 2" x 10"   
x 10 mm.



PIASTRELLA MIX ACQUA 5 x 25 (G 27) 2" x 10"   
x 10 mm.



PIASTRELLA MIX TURCHESE 5 x 25 (G 27) 2" x 10"   
x 10 mm.

SPECIAL ORDER  
BAJO PEDIDO



PIASTRELLA MIX BONE 5 x 25 (G 27) 2" x 10"   
x 10 mm.



PIASTRELLA MIX CAPUCHINO 5 x 25 (G 27) 2" x 10"   
x 10 mm.



PIASTRELLA MIX GREY 5 x 25 (G 27) 2" x 10"   
x 10 mm.



PIASTRELLA MIX OLIVE 5 x 25 (G 27) 2" x 10"   
x 10 mm.

PIEZAS ESPECIALES · SPECIAL PIECES

DEMI-BULLNOSE  
1,5 x 30 (G 07) 0,6" x 11,8"

# POOL

PORCELÁNICO  
PORCELAIN TILE

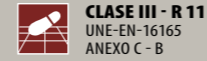

Vaso Piscina / Pool Basin: **Pool Porc. Indigo Antislip Enm. 30,5x30,5**



Vaso Piscina / Pool Basin: **Pool Porc. Iron Antislip Enm. 30,5x30,5**

PIEZAS ESPECIALES · SPECIAL PIECES

- 1 **COMP. INT. CUBRECANTO**  
3 x 3 (G 16) 1" x 1" ◆  
× 11 mm.
- 2 **CUBRECANTO**  
3 x 20 x 3 (G 07) 1" x 8" x 1" ◆  
× 11 mm.
- 3 **COMP. EXT. CUBRECANTO**  
3 x 3 (G 12) 1" x 1" ◆  
× 11 mm.
- 4 **COMP. EXT. MEDIA CAÑA**  
3 x 3 (G 16) 1" x 1" ◆  
× 11 mm.
- 5 **MEDIA CAÑA INT.**  
3 x 20 x 3 (G 07) 1" x 8" x 1" ◆  
× 11 mm.
- 6 **COMP. INT. MEDIA CAÑA**  
3 x 3 (G 12) 1" x 1" ◆  
× 11 mm.

BRILLO GLOSS CLASE I - R9

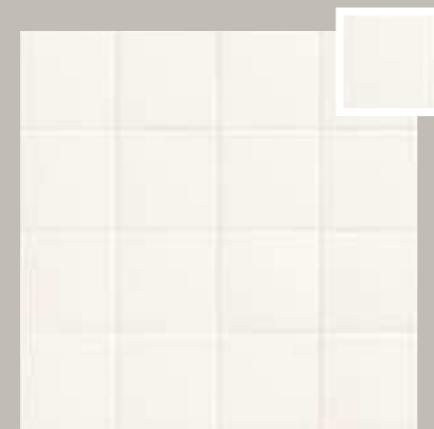

**POOL PORC. LUZ**  
10 x 10 (G 27) 4" x 4"   
ENM. 30,5 x 30,5 (G 42) 11,8" x 11,8"   
× 9 mm.



**POOL PORC. CLOUD**  
10 x 10 (G 27) 4" x 4"   
ENM. 30,5 x 30,5 (G 42) 11,8" x 11,8"   
× 9 mm.



**POOL PORC. IRON**  
10 x 10 (G 27) 4" x 4"   
ENM. 30,5 x 30,5 (G 42) 11,8" x 11,8"   
× 9 mm.

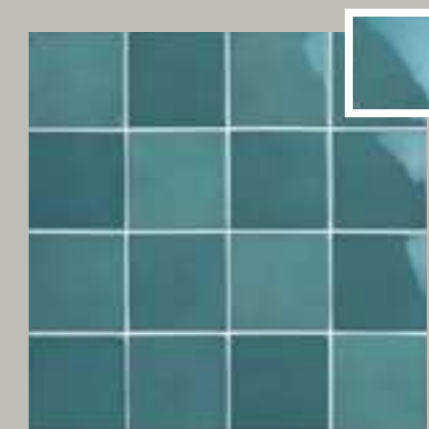

**POOL PORC. EMERALD**  
10 x 10 (G 27) 4" x 4"   
ENM. 30,5 x 30,5 (G 42) 11,8" x 11,8"   
× 9 mm.

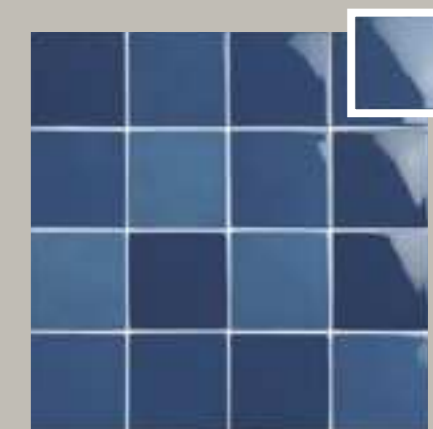

**POOL PORC. INDIGO**  
10 x 10 (G 27) 4" x 4"   
ENM. 30,5 x 30,5 (G 42) 11,8" x 11,8"   
× 9 mm.

SPECIAL ORDER BAJO PEDIDO

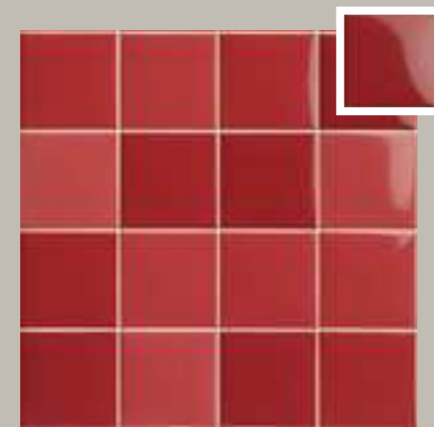

**POOL PORC. ROJO**  
10 x 10 (G 27) 4" x 4"   
ENM. 30,5 x 30,5 (G 42) 11,8" x 11,8"   
× 9 mm.

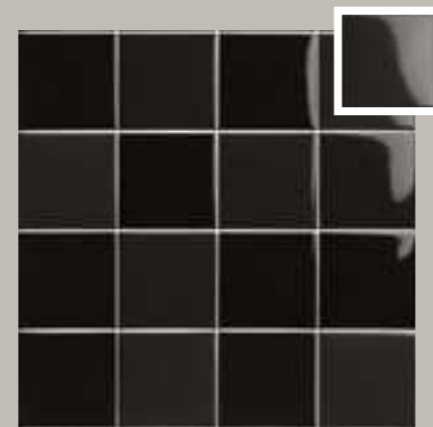

**POOL PORC. NEGRO**  
10 x 10 (G 27) 4" x 4"   
ENM. 30,5 x 30,5 (G 42) 11,8" x 11,8"   
× 9 mm.

MATE MATT CLASE III - R11



**POOL PORC. IRON ANTISLIP**  
10 x 10 (G 78) 4" x 4"   
ENM. 30,5 x 30,5 (G 64) 11,8" x 11,8"   
× 9 mm.



**POOL PORC. EMERALD ANTISLIP**  
10 x 10 (G 78) 4" x 4"   
ENM. 30,5 x 30,5 (G 64) 11,8" x 11,8"   
× 9 mm.



**POOL PORC. INDIGO ANTISLIP**  
10 x 10 (G 78) 4" x 4"   
ENM. 30,5 x 30,5 (G 64) 11,8" x 11,8"   
× 9 mm.

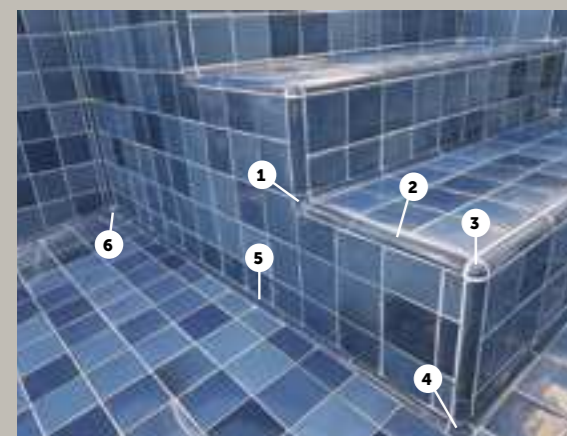

# STOW / STOW MIX

Pasta Blanca  
WHITE BODY



Rev. / Wall: **Stow Bianco 20x60**



Rev. / Wall: **Stow Grafito 20x60 - Stow Mix Grafito 10x10**



Rev. / Wall: **Stow Mix Olive 10x10**

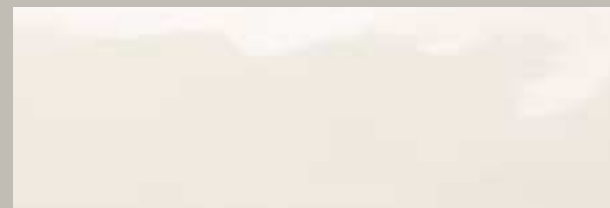

**STOW BIANCO 20 x 60 (G 27)** 8" x 24" **m**  
x 10 mm.

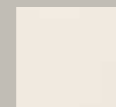

**STOW BIANCO 10 x 10 (G 27)** 4" x 4" **m**  
x 9 mm.



**STOW ASH 20 x 60 (G 27)** 8" x 24" **m**  
x 10 mm.



**STOW ASH 10 x 10 (G 27)** 4" x 4" **m**  
x 9 mm.



**STOW MIX ACQUA 10 x 10 (G 27)** 4" x 4" **m**  
x 9 mm.



**STOW MIX TURCHESE 10 x 10 (G 27)** 4" x 4" **m**  
x 9 mm.

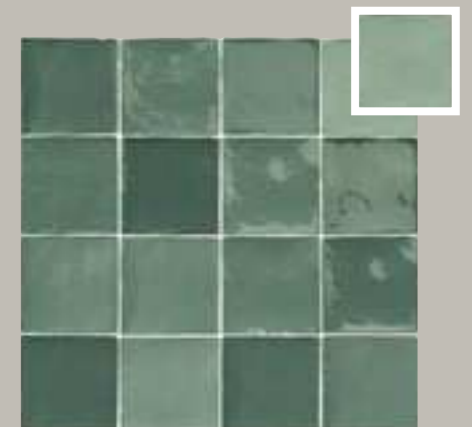

**STOW MIX OLIVE 10 x 10 (G 27)** 4" x 4" **m**  
x 9 mm.

SPECIAL ORDER  
BAJO PEDIDO



**STOW GRAFITO 20 x 60 (G 27)** 8" x 24" **m**  
x 10 mm.



**STOW GRAFITO 10 x 10 (G 27)** 4" x 4" **m**  
x 9 mm.

PIEZAS ESPECIALES - SPECIAL PIECES  
Disponible en STOW y STOW MIX - Available in STOW & STOW MIX

**DEMI-BULLNOSE**  
1,5 x 30 (G 07) 0,6" x 11,8" **d**

SPECIAL ORDER  
BAJO PEDIDO



**STOW MIX GREY 10 x 10 (G 27)** 4" x 4" **m**  
x 9 mm.



**STOW MIX GRAFITO 10 x 10 (G 27)** 4" x 4" **m**  
x 9 mm.

# TABARCA

EXTRUSIONADO PORCELÁNICO  
EXTRUDED PORCELAIN TILE



Rev. / Wall: Tabarca Sal 11x33 · Tabarca Piano Sal 11x22,5



Rev. / Wall: Tabarca Piano Alga 11x22,5

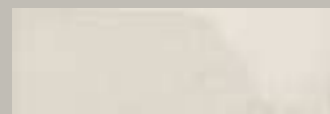

6

TABARCA SAL 11 x 33 (G 73) 4,3" x 13" **m**  
x 10 mm.

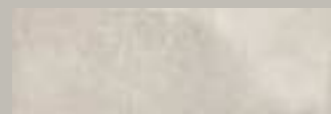

6

TABARCA BRUMA 11 x 33 (G 73) 4,3" x 13" **m**  
x 10 mm.



6

TABARCA ALGA 11 x 33 (G 73) 4,3" x 13" **m**  
x 10 mm.



6

TABARCA HULLA 11 x 33 (G 73) 4,3" x 13" **m**  
x 10 mm.



5

TABARCA PIANO SAL  
11 x 22,5 (G 72) 4,3" x 8,8" **m**  
x 10 mm.



5

TABARCA PIANO BRUMA  
11 x 22,5 (G 72) 4,3" x 8,8" **m**  
x 10 mm.



5

TABARCA PIANO ALGA  
11 x 22,5 (G 72) 4,3" x 8,8" **m**  
x 10 mm.

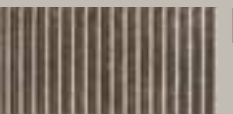

5

TABARCA PIANO HULLA  
11 x 22,5 (G 72) 4,3" x 8,8" **m**  
x 10 mm.

## PIEZAS ESPECIALES - SPECIAL PIECES



DEMI-BULLNOSE  
1,5 x 30 (G 07) 0,6" x 11,8" ◆



# TABARCA

EXTRUSIONADO PORCELÁNICO  
EXTRUDED PORCELAIN TILE

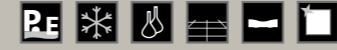

Rev. / Wall: Tabarca Bruma 11x33 • Tabarca Faro 11x33



Pav. / Floor: Tabarca Levante 22,5x22,5



Pav. / Floor: Tabarca Mistral 22,5x22,5

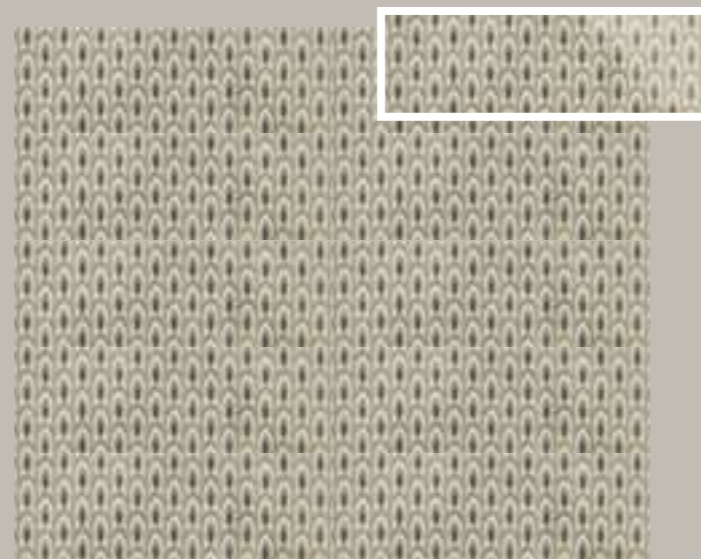

TABARCA FARO 11 x 33 (G 79) 4,3" x 13"  $m^2$   
X 10 mm.

18



TABARCA LEVANTE 22,5 x 22,5 (G 73) 8,8" x 8,8"  $m^2$   
X 10 mm.

36



TABARCA MISTRAL 22,5 x 22,5 (G 73) 8,8" x 8,8"  $m^2$   
X 10 mm.

36

# FRAME

EXTRUSIONADO PORCELÁNICO  
EXTRUDED PORCELAIN TILE

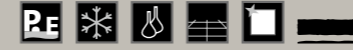

Rev. / Wall: **Frame Beige 15x30**  
Pav. / Floor: **American Melrose Mix 22,5x22,5**



Rev. / Wall: **Frame Sage 15x30**  
Pav. / Floor: **Frame Sage 15x30**



Rev. / Wall: **Frame White 15x30** · **Frame Blue 15x30**



Rev. / Wall: **Frame Blue 15x30** · **Frame Santorini 15x30**  
Pav. / Floor: **Argile Verona 45x45**



**FRAME BEIGE 15 x 30 (G 25) 6" x 12" m²**  
X 10 mm.

1



**FRAME SAGE 15 x 30 (G 25) 6" x 12" m²**  
X 10 mm.

1



**FRAME WHITE 15 x 30 (G 25) 6" x 12" m²**  
X 10 mm.

1

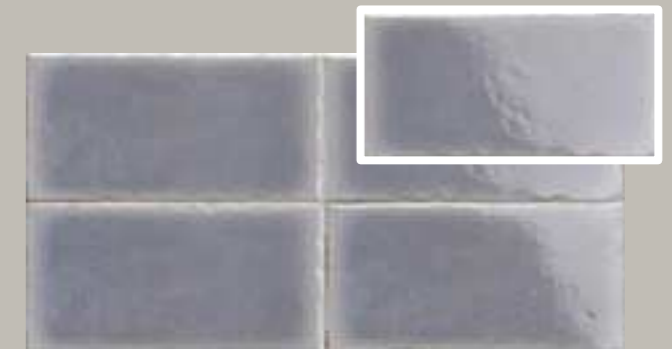

**FRAME BLUE 15 x 30 (G 25) 6" x 12" m²**  
X 10 mm.

1

## PIEZAS ESPECIALES - SPECIAL PIECES

**DEMI-BULLNOSE**  
1,5 x 30 (G 07) 0,6" x 11,8" ◆

## SPECIAL ORDER BAJO PEDIDO



**FRAME RODAS 15 x 30 (G 73) 6" x 12" m²**  
X 10 mm.

4



**FRAME SANTORINI 15 x 30 (G 73) 6" x 12" m²**  
X 10 mm.

4



Rev. / Wall: Tempo Sack Rice 11x22,5



Rev. / Wall: Tempo Sand 11x22,5



28

**TEMPO SACK RICE**  
11 x 22,5 (G 56) 4,3" x 8,8" **m²**  
X 9 mm.



28

**TEMPO RICE**  
11 x 22,5 (G 58) 4,3" x 8,8" **m²**  
X 9 mm.



28

**TEMPO SAND**  
11 x 22,5 (G 58) 4,3" x 8,8" **m²**  
X 9 mm.



28

**TEMPO ATLANTIC**  
11 x 22,5 (G 58) 4,3" x 8,8" **m²**  
X 9 mm.



28

**TEMPO FOSSIL**  
11 x 22,5 (G 58) 4,3" x 8,8" **m²**  
X 9 mm.



28

**TEMPO CAVIAR**  
11 x 22,5 (G 58) 4,3" x 8,8" **m²**  
X 9 mm.

PIEZAS ESPECIALES · SPECIAL PIECES

**SPECIAL ORDER**  
BAJO PEDIDO



**VIERTEAGUAS**  
15 x 22,5/4 (G 10) 5,9" x 8,8"



**DEMI-BULLNOSE**  
1,5 x 30 (G 07) 0,6" x 11,8"



Rev. / Wall: **Tempo Motif Rice 11x11**  
Pav. / Floor: **Tempo Motif Rice 11x11**



Pav. / Floor: **Tempo Pattern Caviar 22,5x22,5**



Rev. / Wall: **Tempo Roads Caviar 22,5x22,5**  
Pav. / Floor: **Tempo Roads Caviar 22,5x22,5**



**TEMPO MOTIF RICE 11 x 11 (G 56)** 4,3" x 4,3" **m²**  
± 9 mm.

14



**TEMPO PATTERN CAVIAR 22,5 x 22,5 (G 57)** 8,8" x 8,8" **m²**  
± 9 mm.

14



**TEMPO ROADS CAVIAR 22,5 x 22,5 (G 57)** 8,8" x 8,8" **m²**  
± 9 mm.

14



**TEMPO ROADS CAVIAR PERMITE MÚLTIPLES POSIBILIDADES COMPOSITIVAS**  
TEMPO ROADS CAVIAR OFFERS INFINITE COMPOSITIVE POSSIBILITIES

# MARE NOSTRUM

EXTRUSIONADO PORCELÁNICO  
EXTRUDED PORCELAIN TILE



Rev. / Wall: Mare Nostrum Messina 7x45 · Mare Nostrum Ibiza 7x45



Pav. / Floor: Mare Nostrum Hex Niza 18x20,5



Rev. / Wall: Provenzal Niza 26,5x20,5 · Provenzal Ibiza 26,5x20,5  
Pav. / Floor: Provenzal Niza 26,5x20,5 · Provenzal Ibiza 26,5x20,5

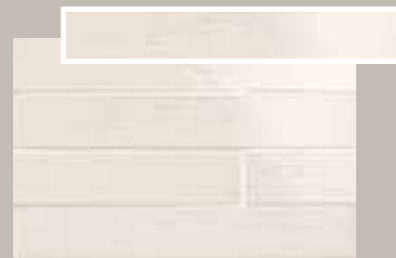

**MARE NOSTRUM IBIZA**  
7 x 45 (G 27) 3" x 17,7" **m²**  
± 9 mm.



**MARE NOSTRUM IBIZA**  
18 x 18 (G 57) 7" x 7" **m²**  
± 9 mm.



**MARE NOSTRUM MESSINA**  
7 x 45 (G 27) 3" x 17,7" **m²**  
± 9 mm.



**MARE NOSTRUM MESSINA**  
18 x 18 (G 57) 7" x 7" **m²**  
± 9 mm.



**MARE NOSTRUM MÓNACO**  
7 x 45 (G 27) 3" x 17,7" **m²**  
± 9 mm.



**MARE NOSTRUM NIZA**  
7 x 45 (G 27) 3" x 17,7" **m²**  
± 9 mm.



**MARE NOSTRUM NIZA**  
18 x 18 (G 57) 7" x 7" **m²**  
± 9 mm.



**MARE NOSTRUM GÉNOVA**  
7 x 45 (G 27) 3" x 17,7" **m²**  
± 9 mm.



**MARE NOSTRUM GÉNOVA**  
18 x 18 (G 57) 7" x 7" **m²**  
± 9 mm.

## PIEZAS ESPECIALES · SPECIAL PIECES

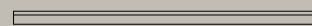

**DEMI-BULLNOSE**  
1,5 x 30 (G 07) 0,6" x 11,8" **m²**

## SPECIAL ORDER BAJO PEDIDO



**MARE NOSTRUM HEX. IBIZA**



**PROVENZAL IBIZA**

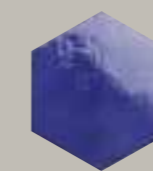

**MARE NOSTRUM HEX. MESSINA**

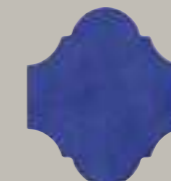

**PROVENZAL MESSINA**

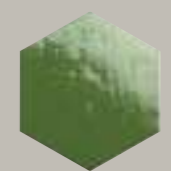

**MARE NOSTRUM HEX. MÓNACO**

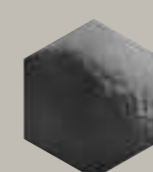

**MARE NOSTRUM HEX. NIZA**



**PROVENZAL NIZA**

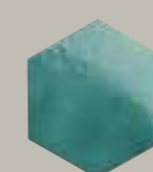

**MARE NOSTRUM HEX. GÉNOVA**

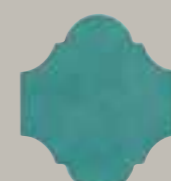

**PROVENZAL GÉNOVA**

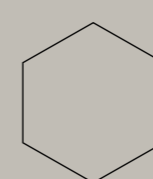

**18 x 20,5 (G 39)**  
7" x 8" **m²**  
± 10 mm.

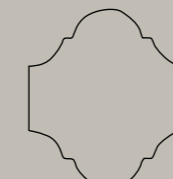

**26,5 x 20,5 (G 55)**  
10,3" x 8" **m²**  
± 10 mm.

# Packing Bases

PAVIMENTO FLOOR TILE / SOLS

	FORMATO	ESPEJOR	PULGADAS	PZ CAJA	M²	CAJA PLT	PESO CAJA	PESO PLT
	SIZE	THICKNESS	SIZES IN INCHES	PC BOX	M²	BOX PLT	WEIGHT BOX	WEIGHT PLT
ALQUEZAR	20 x 120	9	8" x 48"	5	1,2	48	24 ,27	1.180
ALMA	90 x 90	9,5	35,4" x 35,4"	2	1,62	27	39,70	1.090
ALPES	60 x 120	9	23,6" x 48"	2	1,44	36	29,03	1.060
ANIMA	90 x 90	9	35,4" x 35,4"	2	1,62	32	33,1	1.074
	22,5 x 22,5	10	8,8" x 8,8"	20	1,01	66	20,7	1.505
ARGILE	22,5 x 22,5	12	8,8" x 8,8"	16	0,81	72	21	1.560
	22,5 x 45	12	8,8" x 17,7"	8	0,81	72	21	1.560
	45 x 45	12	17,7" x 17,7"	5	1,01	64	27,1	1.738,88
	15 x 15	10	5,9" x 5,9"	19	0,43	120	9,5	1.150
	4 x 4	10	2" x 2"	120	0,192	112	4,8	565
ARGILE ARROW	7,4 x 48	10	3" x 19"	20	0,71	65	16	1.060
ARGILE STAR	18 x 18	10	7" x 7"	16	0,60	60	12,8	800
ARGILE CRUZ	18 x 18	10	7" x 7"	16	0,52	60	9,17	565
ARGILE LOSG.	18 x 45	12	7" x 17,7"	11	4,95	40	13	530
ARGILE DECOR	22,5 x 22,5	10	8,8" x 8,8"	20	1,01	66	20,98	1.533
	15 x 45	10	5,9" x 17,7"	12	0,81	75	18	1.332
ARTIES	30,3 x 61,3	10	12" x 24"	7	1,30	40	25	1.000
BOSTON	6,5 x 25	10	2,5" x 10"	27	0,439	121	9,6	1.705
	25 x 50	10	10" x 20"	6	0,75	40	15,90	651
	22,5 x 45	10	8,8" x 17,7"	10	1,01	72	21,2	1.540
	11 x 22,5	10	4,3" x 8,8"	20	1	66	10,5	1.359
	22,5 x 22,5	10	8,8" x 8,8"	20	1,01	66	20,07	1.505
	36 x 36	10	14" x 14"	8	1	48	22,04	1.072
BOSTON HEX	28,5 x 32,5	10	11,2" x 12,7"	15	1,05	48	21,9	1.063
BOSTON HEX	36 x 41,5	10	14" x 16,2"	9	1	48	22,6	1.103
BOTANICA	25 x 150	10	10" x 60"	4	1,5	40	35	1.420
CERELR	33,3 x 33,3	10	13,1" x 13,1"	12	1,33	48	24,50	1.176
COTTO NATURE	36 x 36	10	14" x 14"	8	1	48	22,04	1.072
	18 x 36	10	7" x 14"	16	1	72	22,8	1.660
	18 x 18	10	7" x 7"	30	0,97	48	21,4	1.555
	30 x 30	9	11,8" x 11,8"	11	1	48	18,95	1.380
CTO. NATURE LOSAGNA	18 x 36	9	7" x 14"	16	1,04	72	22,82	1.657
COTTAGE	60 x 60	12	23,6" x 23,6"	4	1,44	24	36	1.296
	30 x 30	12	11,8" x 11,8"	9	0,82	48	22	1.555
	4 x 4	12	1,5" x 1,5"	120	4,80	112	4,8	564
COTTAGE STAR	15,5 x 15,5	10	6" x 6"	16	0,39	120	9	1.085
COTTAGE CROSS	15,5 x 15,5	10	6" x 6"	24	0,59	80	10	780
COTTO BRICK	7 x 60	10	3" x 24"	24	1	66	22,5	1.480
D'ANTICATTO	22,5 x 22,5	10	8,8" x 8,8"	20	1,01	66	20,7	1.505
	22,5 x 45	10	8,8" x 17,7"	10	1,01	72	21,2	1.540
	11 x 22,5	10	4,3" x 8,8"	20	1	66	10,5	1.359
FIORANO	15 x 15	10	5,9" x 5,9"	19	0,43	120	9,5	1.150
	15 x 45	10	5,9" x 17,7"	12	0,81	75	18	1.332
FUEGO	45 x 45	12	17,7" x 17,7"	5	1,01	64	27,1	1.738,88
	22,5 x 22,5	12	8,8" x 8,8"	16	0,81	72	21	1.560
	15 x 30	11	6" x 12"	19	0,86	52	20	1.040

	FORMATO	ESPEJOR	PULGADAS	PZ CAJA	M²	CAJA PLT	PESO CAJA	PESO PLT
	SIZES	THICKNESS	SIZES IN INCHES	PC BOX	M²	BOX PLT	WEIGHT BOX	WEIGHT PLT
FUEGO	6,5 x 25	11	2,5" x 10"	27	0,44	121	9,58	1.180
HERITAGE GLAY	120 x 120	8	48" x 48"	1	1,44	50	27	1.350
	60 x 120 x 2	20	24" x 48" x 1"	2	1,44	18	58,50	1.053
	60 x 90 x 2	20	24" x 36" x 1"	2	1,08	22	45	990
	60 x 120	8	24" x 48"	2	1	40	27	1.080
	60 x 60	8	24" x 24"	4	1,44	40	23	966
	30 x 60	8	12" x 24"	8	1,44	48	26,50	1.272
	30 x 30 ENM	8	12" x 12"	11	1	42	23	966
LANDS	60 x 60	12	23,6" x 23,6"	4	1,44	24	36	1.296
	45 x 45	12	17,7" x 17,7"	5	1,012	52	27,17	1.760
	22,5 x 22,5	12	8,8" x 8,8"	16	0,81	66	21,41	1.557
	11 x 22,5	10	4,3" x 8,8"	20	0,8	66	10,5	1.359
LANDS STAR	15,5 x 15,5	10	6" x 6"	16	0,39	120	9	1.085
LANDS CROSS	15,5 x 15,5	10	6" x 6"	24	0,59	80	10	780
LIMESTONE	60 x 60	11	23,6" x 23,6"	4	1,44	24	36	1.296
	30 x 30	12	11,8" x 11,8"	9	0,82	48	22	1.555
LIMESTONE STAR	15,5 x 15,5	10	6" x 6"	16	0,39	120	9	1.085
LIMESTONE CROSS	15,5 x 15,5	10	6" x 6"	24	0,59	80	10	780
NATUR-TECH	20 x 90/2,6	26	8" x 35,4"/1"	2	0,36	48	16	783
	20 x 45/2,6	26	8" x 17,7"/1"	4	0,36	80	16	1.295
NATUR-TRANSIT	20 x 20/2	20	8" x 8"	12	0,48	64	21,3	1.380
	20 x 30/2	20	8" x 11,8"	9	0,54	64	23,85	1.543
NATUR-TRANSIT GO	20 x 20	20	8" x 8"	12	0,48	64	21,70	1.404
NATUR-TRANSIT STOP	20 x 20	20	8" x 8"	12	0,48	64	22,9	1.481
NATURA	25 x 150	10	10" x 60"	4	1,5	40	35	1.420
	20 x 120	9	8" x 48"	5	1,2	48	24,27	1.180
OLIMPO	60 x 120	9	23,6" x 48"	2	1,44	36	29,03	1.060
ORION	90 x 90	9	35,4" x 35,4"	2	1,62	32	33,1	1.074
PARK	20 x 120	9	8" x 48"	5	1,2	48	24,27	1.180
PIEDRAS DEL BRUC	45 x 67,5	12	17,7" x 26,5"	5	1,52	32	41,75	1.350
	22,5 x 67,5	12	8,8" x 26,5"	7	1,06	48	29,05	1.410
PIEMONTE	36 x 36	10	14" x 14"	8	1	48	22,04	1.072
	18 x 36	9	7" x 14"	16	1	48	22,8	1.660
	18 x 18	9	7" x 7"	30	0,97	48	21,4	1.555
	4 x 4	9	2" x 2"	120	0,192	110	4,8	565
	5 x 5	9	2" x 2"	115	0,29	112	2,7	318
PIEMONTE STAR	15,5 x 15,5	9	6" x 6"	20	0,48	60	11,5	705
PIEMONTE LOSG.	15,5 x 36	9	6" x 14"	16	0,89	60	20,26	1.150
PIEMONTE LOSG.	18 x 36	9	7" x 14"	16	1,04	72	22,82	1.657
PIRINEOS	33 x 66,5	9	13" x 26,5"	7	1,54	48	30,1	1.465
	15 x 15	9	6" x 6"	22	0,5	110	8,9	994
POSETS	18 x 36	9	7" x 14"	16	1	48	22,8	1.660
	18 x 18	9	7" x 7"	30	0,97	48	21,4	1.555
POSETS A/S	60 x 120	9	23,6" x 48"	2	1,44	36	29,03	1.060
	36 x 72	9	14" x 28"	5	1,25	48	27,25	1.325
	36 x 36	9	14" x 14"	8	1	48	22,04	1.072

	FORMATO	ESPEJOR	PULGADAS	PZ CAJA	M²	CAJA PLT	PESO CAJA	PESO PLT
	SIZES	THICKNESS	SIZES IN INCHES	PC BOX	M²	BOX PLT	WEIGHT BOX	WEIGHT PLT
RETRO	21 x 60	10	8" x 23,6"	8	1	72	21,5	1.580
	7 x 60	10	3" x 23,6"	24	1	66	22,25	1.483
RETRO HEX	36 x 41,5	10	14" x 16,2"	9	1	48	22,6	1.103
SANDRO	6,5 x 6,5	10	3" x 3"	60	3,9	60	4,90	309
SARSEN STONE	160 x 160	8	64" x 64"	1	2,56	20	48,62	972,40
	120 x 120	8	48" x 48"	1	1,44	50	27	1.350
	60 x 120 x 2	20	24" x 48" x 1"	2	1,44	18	58,50	1.053
	60 x 90 x 2	20	24" x 36" x 1"	2	1,08	22	45	990
	60 x 120	8	24" x 48"	2	1	40	27	1.080
	60 x 60	8	24" x 24"	4	1,44	40	23	966
	30 x 60	8	12" x 24"	8	1,44	48	26,50	1.272
	30 x 30 ENM	8	12" x 12"	11	1	42	23	966
SAONA	30,3 x 61,3	10	12" x 24"	7	1,30	40	25	1.000
SHERWOOD	30 x 180	10	11,8" x 72"	1	0,62	50	45	2.250
	25 x 150	10	10" x 60"	4	2,67	40	35	1.400
	20 x 120	9	8" x 48"	7	4,17	44	32	1.408
TECH GEO	22,5 x 33	14	8,8" x 13"	11	0,82	68	23,80	1.640
	22,5 x 22,5	14	8,8" x 8,8"	17	0,86	60	23,19	1.406
	11 x 22,5	14	4,3" x 8,8"	20	0,5	128	14,1	1.820
TECH LAND	30 x 30	14	11,8" x 11,8"	10	0,90	60	25	1.520
	22,5 x 33	14	8,8" x 13"	11	0,82	68	23,80	1.640
	11 x 22,5	14	4,3" x 8,8"	20	0,5	128	14,1	1.820
	22,5 x 22,5	14	8,8" x 8,8"	17	0,86	60	23,19	1.406
TECH LAND STAR	15,5 x 15,5	14	6" x 6"	12	0,34	96	9,9	966
TECH LAND CROSS	15,5 x 15,5	14	6" x 6"	18	0,43	105	10,40	1.107
TOSCANA	33,3 x 33,3	10	13,1" x 13,1"	12	1,33	48	24,50	1.176
UNIKA	22,5 x 22,5	10	8,8" x 8,8"	20	1,01	66	20,7	1.505
	22,5 x 45	10	8,8" x 17,7"	10	1,01	72	21,1	1.540
	11 x 22,5	10	4,3" x 8,8"	40	1	66	21,22	1.542
	4 x 4	10	2" x 2"	120	0,192	112	4,8	565
UNIKA STAR	15,5 x 15,5	10	6" x 6"	16	0,39	120	9	1.085
UNIKA CROSS	15,5 x 15,5	10	6" x 6"	24	0,59	80	10	780
VENICE	15 x 45	10	5,9" x 17,7"	12	0,81	75	18	1.332
VENICE	4 x 4	10	2" x 2"	120	0,192	112	4,8	565
VENICE	5 x 5	10	2" x 2"	115	0,29	112	2,7	318
VENICE	18 x 18	10	7" x 7"	16	0,60	60	12,8	800
VENICE	15 x 15	10	5,9" x 5,9"	19	0,43	120	9,5	1.150
VERSILIA	4 x 4	10	2" x 2"	120	0,192	112	4,8	565
	5 x 5	10	2" x 2"	115	0,29	112	2,7	348
	8 x 8	10	3" x 3"	25	0,16	72	3,35	256
	8 x 36	10	3" x 14"	30	0,86	72	18,10	1.318
	15,5 x 36	10	6" x 14"	15	0,84	72	18,1	1.318
VERSILIA FRNT.	15,5 x 15,5	10	6" x 6"	32	0,77	565	18,3	1.042
VERSILIA ESTR.	15,5 x 15,5	10	6" x 6"	15	0,36	60	8,55	534
VERSILIA ESTR.	18 x 18	10	7" x 7"	15	0,48	60	10,75	660
VERSILIA ESTR.	36 x 36	10	14" x 14"	8	1,04	40	22,5	915
VOLTERRA	4 x 4	10	2" x 2"	120	0,192	112	4,8	565
ZERMATT	25 x 150	10	10" x 60"	3				

# Packing Piezas Especiales

PIEZAS ESPECIALES PAVIMENTO SPECIAL PIECES FLOOR TILE / PIÈCES SPÉCIALES POUR REVÊTEMENT DE SOL



	FORMATO	ESPESOR	PULGADAS	PZ CAJA	ML	CAJA PLT	PESO CAJA	PESO PLT
	SIZES	THICKNESS	SIZES IN INCHES	PC BOX	ML	BOX PLT	WEIGHT BOX	WEIGHT PLT
ÁNG. GRATING	25 x 50 x 35/2,2	22	10" x 20" x 15"/1"	4	2	45	16	735
ÁNG. PELD. ANG.	32 x 45/3	11	12,5" x 17,7"/1"	2	0,32	90	3,20	300
	32 x 45/4	11	12,5" x 17,7"/1,5"	2	0,32	90	3,16	308
ÁNG. PELD. ANG. INT./EXT.	66,5 x 32 x 45/3	11	26,5" x 12,5" x 17,7"/1"	2	1,35	20	10,1	217
	67,5 x 32 x 45/3	11	26,5" x 12,5" x 17,7"/1"	2	1,35	20	10,2	220
ÁNG. PELD. CV 4 PZ.	33 x 33/4	12	13" x 13"/1,5"	1	0,33	90	3,46	325
ÁNG. PELD. CV.	33 x 46/4	12	13" x 18"/1,5"	2	0,33	90	3,46	325
ÁNG. PELD. RCT.	33 x 45/3	11	13" x 17,7"/1"	2	0,32	90	3,4	326
ÁNG. PELD. ANG. 120 INT./EXT.	120 x 32 x 45/3	11	48" x 12,5" x 17,7"/1"	2	2,4	14	18	267
ÁNG. PELD. RCT. 120 INT./EXT.	120 x 33 x 45/3	11	48" x 13" x 17,7"/1"	2	2,4	14	18	253
ÁNG. PELD. RCT. 150 INT./EXT.	150 x 33 x 45/3	11	60" x 13" x 17,7"/1"	2	3	16	22,5	375
ÁNG. PELD. RCT. 61,3 INT./EXT.	61,3 x 32 x 46/3	11	24" x 12,5" x 18"/1"	2	0,29	28	18	504
BORDE PISCINA	28 x 66,5/4	40	10" x 26,5"/1,5"	2	1,35	32	22	719
	28 x 67,5/4	40	10" x 26,5"/1,5"	2	1,35	32	22	719
	45 x 120/3	30	17,7" x 48"/1"	1	0,54	38	14,50	551
	45 x 60/3	30	17,72 x 24"/1"	-	-	-	-	-
	61,3 x 28/4	40	24" x 11"/15"	2	0,35	32	20,08	643
CANALETA	15 x 20/2	20	5,9" x 8"/1"	9	1,8	120	7,26	899
CANALETA DESAGÜE	15 x 20/2	20	5,9" x 8"/1"	9	1,8	120	6,40	795
C. EXT. MEDIA CAÑA	4 x 4	20	1,5" x 1,5"	18	0,6	-	1,34	-
C. INT. MEDIA CAÑA	4 x 4	20	1,5" x 1,5"	20	0,66	-	1,84	-
C. EXT. CUBRECANTO	4 x 4	20	1,5" x 1,5"	25	0,83	-	0,55	-
C. INT. CUBRECANTO	4 x 4	20	1,5" x 1,5"	10	0,33	-	0,85	-
C. EXT. ZÓCALO ANG.	4 x 4	20	2,5" x 1,5"	18	0,72	-	2,6	-
C. INT. ZÓCALO ANG.	4 x 4	20	2,5" x 1,5"	18	0,72	-	1,75	-
CUBRECANTO	4 x 30 x 4	20	1,5" x 11,8" x 1,5"	26	7,8	-	7,33	-
ESQ. INT./EXT. DESBORD.	30,5 x 50 x 40/2,4	24	11,8" x 20" x 16"/1"	4	2	38	14,50	566
DEMI-BULLNOSE	1,5 x 30	8	0,6" x 11,8"	50	15	120	2,2	276
DESBORDANTE	30,5 x 50/2,4	24	11,8" x 20"/1"	4	2	38	19,40	762
ESQ. EXT./INT. BORDE PISCINA	28 x 66,5 x 43/4	40	10" x 26,5" x 17"/1,5"	2	1,35	32	16,50	545
	28 x 67,5 x 43,5/4	40	10" x 26,5" x 17"/1,5"	2	1,35	32	16,50	545
	61,3 x 28 x 43,5/4		24" x 12" x 16"/1"					
FRONTAL	15 x 120	9	6" x 48"	8	9,6	14	33,7	490
GRATING	25 x 50/2,2	22	10" x 20"/1"	5	2,5	42	21,2	905
MEDIA CAÑA INT.	4 x 30 x 4	20	1,5" x 11,8" x 1,5"	22	6,6	-	9,91	-
PASAMANOS	18 x 33,3/4	12	7" x 13,1"/1,5"	7	0,42	70	15	1.050
PELDAÑO ANG.	32 x 32/4	12	12,5" x 12,5"/1,5"	4	1,28	54	11,55	640
	120 x 32/3	11	48" x 12,5"/1"	2	2,4	14	19,2	284
	60 x 32/3	11	23,6" x 12,5"/1"	2	1,2	28	9,6	284
	66,5 x 32/3	11	26,5" x 12,5"/1"	2	1,35	20	13,7	289
	67,5 x 32/3	11	26,5" x 12,5"/1"	2	1,35	20	13,7	289
PELDAÑO CV.	22,5 x 33/4	12	8,8" x 13"/1,5"	6	1,35	64	13	845
PELDAÑO CV.	30 x 33/4	12	11,8" x 13"/1,5"	4	1,2	46	11,94	660
	36 x 33/4	12	14" x 13"/1,5"	4	1,44	46	12,9	730
	45 x 33/4	12	17,7" x 13"/1,5"	4	1,8	46	16,20	895
	60 x 33/4	12	23,6" x 13"/1,5"	2	1,2	24	11,50	291
PEDAÑO BLOCK	120 x 33/1,4	-	48" x 13"/05"	2	2,40	40	22	880

## PIEZAS ESPECIALES REVESTIMIENTO SPECIAL PIECES WALL TILE / PIÈCES SPÉCIALES POUR REVÊTEMENT

	FORMATO	ESPESOR	PULGADAS	PZ CAJA	ML	CAJA PLT	PESO CAJA	PESO PLT
	SIZES	THICKNESS	SIZES IN INCHES	PC BOX	ML	BOX PLT	WEIGHT BOX	WEIGHT PLT
PELDAÑO RCT.	45 x 33/3	11	17,7" x 12,5"/1"	4	1,8	46	16,30	895
	60 x 33/3	11	23,6" x 13"/1"	2	1,2	28	9,6	285
	120 x 33/3	11	48" x 13"/1"	2	2,4	14	19,2	282
	150 x 33/3	11	60" x 13"/1"	2	3	16	25,1	416
PELDAÑO RCT. CON GOTERÓN	61,3 x 32/3	11	24" x 12,5"/1"	2	0,40	28	20	560
	33,3 x 33,3/3	11	13,1" x 12,6"/1"	4	0,44	46	10,90	588,60
REMATE ANG.	20 x 90/2,6	26	8" x 35,4"	2	0,36	48	16,5	810
	20 x 45/2,6	26	8" x 17,7"/1"	4	0,36	80	16	1.295
REMATE PELD. ANG. IZD/DRCH.	3 x 32	8	1" x 12,5"	20	6,4	60	3,5	219
REMATE PELD. RCT. IZD/DRC	3 x 33	9	1" x 13"	20	6,4	60	3,5	219
REMATE TRIÁNGULO	20 x 6,5/2,6	26	8" x 2,5"/1"	22	4,4	120	7,6	925
VIERTAGUAS	15 x 22,5/4	12	5,9" x 8,8"/1,5"	14	3,15	64	15,08	980
	15 x 30/4	12	5,9" x 11,8"/1,5"	14	4,2	45	20,5	940
	15 x 33,3/4	12	5,9" x 13,1"/1,5"	10	0,50	36	13,20	475,20
ZÓCALO ANG.	6 x 30/4	20	2,5" x 11,8"/1,5"	16	4,8	96	10,3	1.004
ZÓCALO	8,5 x 60	9	3,5" x 23,6"	16	9,6	72	16,26	1.186
	8,5 x 90	9	3,5" x 35,4"	9	8,10	66	8,65	585
	9 x 30	10	3,5" x 11,8"	30	9	56	19,6	1.112
	9 x 36	10	3,5" x 14"	30	10,8	48	22,6	1.100
	9 x 45	10	3,5" x 17,7"	15	6,75	80	15,5	1.260
	9,8 x 60	9	3,9" x 23,6"	16	9,6	72	22	1.595
	9,8 x 66,5	9	3,9" x 26,5"	8	2,12	63	10	646
	9,8 x 75	9	4" x 30"	11	8,25	77	19,25	1.497
	9,8 x 120	9	3,9" x 48"	8	9,6	63	22	1.400
	9 x 30,3	9	3,5" x 11,9"	20	0,55	96	12,80	1.228,50
	8 x 33,3	9	3" x 13,1"	22	0,66	84	13,20	1.108
ZANQUÍN CV.	9 x 30	10	3,5" x 11,8"	30	9	56	16,241	924
	9 x 36	10	3,5" x 14"	30	10,8	48	20,2	990
	9 x 45	10	3,5" x 17,7"	15	6,75	80	12,40	1.007
	8 x 33,3	10	3" x 13,1"	22	0,66	84	13,20	1.133,80
ZANQUÍN ANG.	8,5 x 30	9	3,5" x 11,8"	30	9	48	16,24	794
	9 x 30	10	3,5" x 11,8"	30	9	56	16,24	924
	9,8 x 30	9	3,9" x 11,8"	30	9	48	16,24	800
	9 x 45	10	3,5" x 17,7"	15	6,78	80	12,21	992
	9,8 x 66,5	9	3,9" x 26,5"	8	2,12	63	10	646
ZANQUÍN RCT.	8,5 x 30	9	3,5" x 11,8"	30	9	48	16,24	794
	9 x 30	10	3,5" x 11,8"	30	9	56	16,24	924
	9,8 x 30	9	4" x 11,8"	30	9	48	16,24	795
	9 x 45	10	3,5" x 17,7"	15	6,75	80	12,40	1.007
	9 x 30,3	10	3,5" x 11,9"	20	0,55	96	11	1.228,80
	8 x 33,3	10	3" x 13,1"	22	0,66	84	13,20	1.133,80

	FORMATO	ESPESOR	PULGADAS	PZ CAJA	ML	CAJA PLT	PESO CAJA	PESO PLT
	SIZES	THICKNESS	SIZES IN INCHES	PC BOX	ML	BOX PLT	WEIGHT BOX	WEIGHT PLT
C. INT. CUBRECANTO	4 x 4	11	1,5" x 1,5"	100	3	196	1,6	310
C. EXT. CUBRECANTO	4 x 4	11	1,5" x 1,5"	100	3	196	0,85	182
C. INT. MEDIA CAÑA	4 x 4	11	1,5" x 1,5"	100	3	196	0,85	182
C. EXT. MEDIA CAÑA	4 x 4	11	1,5" x 1,5"	100	3	196	1,6	310
CUBRECANTO	4 x 30 x 4	11	1,5" x 11,8" x 1,5"	36	7,2	196	1,98	405
DEMI-BULLNOSE	1,5 x 30	8	0,6" x 11,8"	50	15	120	2,2	276
MEDIA CAÑA INT.	4 x 30 x 4	11	1,5" x 11,8" x 1,5"	36	7,2	196	1,98	405
PENCIL	2,5 x 30	8	1" x 11,8"	30	9	196	2	410
VIERTAGUAS	15 x 22,5/4	12	5,9" x 8,8"	14	3,15	64	15,08	980

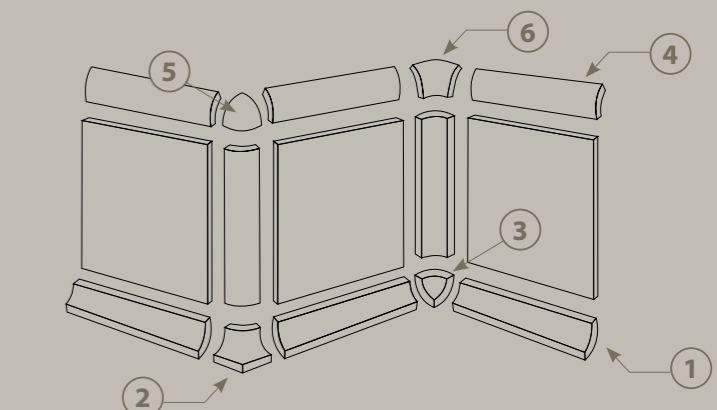
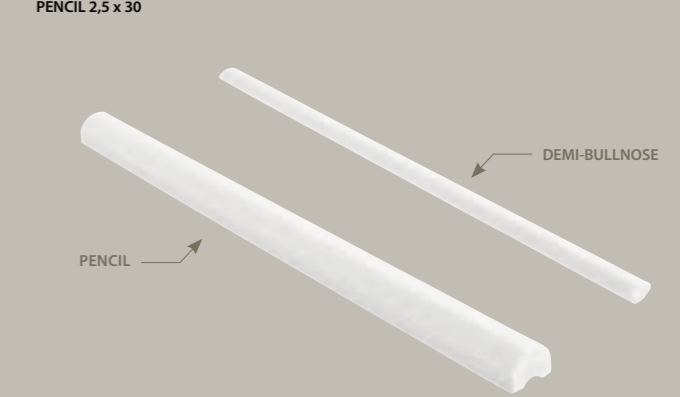
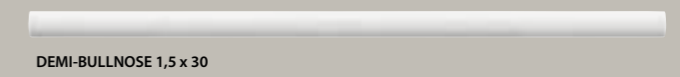



# ESTAMOS CONECTADOS

WE ARE CONNECTING  
RESTONS CONNECTÉS

En Natucer, creemos en la importancia de mantenernos conectados con nuestros clientes y colaboradores. Por eso nos aseguramos de ofrecer contenido actualizado a diario a través de nuestras plataformas digitales, como la web y las redes sociales, brindándote información sobre nuestras colecciones más recientes, tendencias en diseño cerámico y todo aquello que define nuestro compromiso con la innovación y la calidad.

**Síguenos** y descubre un mundo de inspiración cerámica diseñado especialmente para ti.

In Natucer, we believe in the importance of staying connected with our customers and partners. That's why we make sure to offer updated content daily through our digital platforms, such as our website and social media, providing you with information about our latest collections, trends in ceramic design, and everything that defines our commitment to innovation and quality.

**Follow us** and discover a world of ceramic inspiration specially designed for you.

Chez Natucer, nous croyons en l'importance de rester connectés avec nos clients et collaborateurs. C'est pourquoi nous proposons un contenu actualisé quotidiennement via notre site web et nos réseaux sociaux : collections, tendances en design céramique et innovations qui définissent notre engagement envers la qualité.

**Suivez-nous** et découvrez un univers d'inspiration céramique conçu spécialement pour vous.

